



MEIRAGTx

## R&D Day: Gene Regulation Platform

December 15, 2021

This presentation contains forward-looking statements within the meaning of the Private Securities Litigation Reform Act of 1995. All statements contained in this presentation that do not relate to matters of historical fact should be considered forward-looking statements, including, without limitation, statements regarding the development of our promoter platforms and gene regulation technology and related data, including in light of the COVID-19 pandemic, as well as statements that include the words “expect,” “intend,” “plan,” “believe,” “project,” “forecast,” “estimate,” “may,” “should,” “anticipate” and similar statements of a future or forward-looking nature. These forward-looking statements are based on management’s current expectations. These statements are neither promises nor guarantees, but involve known and unknown risks, uncertainties and other important factors that may cause actual results, performance or achievements to be materially different from any future results, performance or achievements expressed or implied by the forward-looking statements, including, but not limited to, our incurrence of significant losses; any inability to achieve or maintain profitability, raise additional capital, identify additional and develop existing product candidates, successfully execute strategic priorities, bring product candidates to market, expansion of our manufacturing facilities and processes, successfully enroll patients in and complete clinical trials, accurately predict growth assumptions, recognize benefits of any orphan drug designations, retain key personnel or attract qualified employees, or incur expected levels of operating expenses; the impact of the COVID-19 pandemic on the status, enrollment, timing and results of our clinical trials and on our business, results of operations and financial condition; failure of early data to predict eventual outcomes; failure to obtain FDA or other regulatory approval for product candidates within expected time frames or at all; the novel nature and impact of negative public opinion of gene therapy; failure to comply with ongoing regulatory obligations; contamination or shortage of raw materials or other manufacturing issues; changes in healthcare laws; risks associated with our international operations; significant competition in the pharmaceutical and biotechnology industries; dependence on third parties; risks related to intellectual property; changes in tax policy or treatment; our ability to utilize our loss and tax credit carryforwards; litigation risks; and the other important factors discussed under the caption “Risk Factors” in our most recent quarterly report on Form 10-Q or annual report on Form 10-K or subsequent 8-K reports, as filed with the Securities and Exchange Commission. These and other important factors could cause actual results to differ materially from those indicated by the forward-looking statements made in this presentation. Any such forward-looking statements represent management’s estimates as of the date of this presentation. While we may elect to update such forward-looking statements at some point in the future, unless required by law, we disclaim any obligation to do so, even if subsequent events cause our views to change. Thus, one should not assume that our silence over time means that actual events are bearing out as expressed or implied in such forward-looking statements. These forward-looking statements should not be relied upon as representing our views as of any date subsequent to the date of this presentation. Unless otherwise stated or the context otherwise requires, the information herein is as of December 15, 2021.





## A Vertically Integrated, Clinical Stage Gene Therapy Company Developing a new pharmaceutical modality for the cost-effective treatment of a broad range of serious disorders

### Diversified Pipeline of Gene Therapy Candidates

#### 6 ongoing clinical programs:

- Inherited retinal diseases
- Salivary gland
- Parkinson's disease



### Platform of Core Viral Vector Engineering Capabilities

#### Viral vector design platform:

- Capsids
- Promoters
- 5', 3' and intronic regulatory elements, transgene optimization, poly A ITRs
- Immunogenicity



### cGMP Manufacturing Capacity & Commercial Ready Process

- **Flexible and scalable cGMP manufacturing facilities** with quality and capacity for commercial supply
- **Internal Plasmid production** for GMP and Analytics for QC release and stability
- **Process Development Platform fit for commercial supply**



### Next Generation Gene Regulation Platform

- **Proprietary technology** allows precise control of gene therapy expression level via dose response to orally delivered small molecules
- Transformative technology **platform** with unprecedented dynamic range
- Potentially applicable to any gene, any vector with synthetic small molecule properties designed specifically for each gene and indication

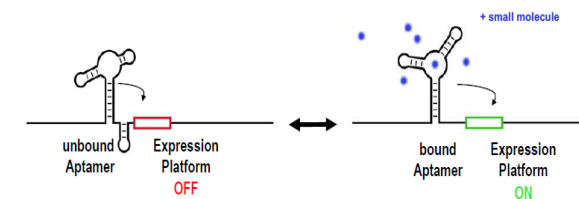

## Capsid



### Tissue Tropism

- Differential transduction efficiency
- Potency

### Capsid Engineering

- Directed evolution
- Screening

## Vector Genome

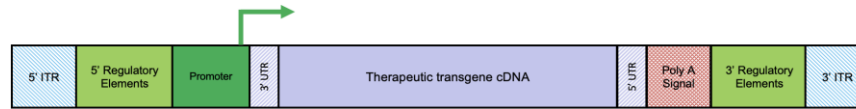

### Expression Levels and Cell Specificity

- Potency
- Efficacy
- Safety

### DNA encoded regulatory elements

- Promoter
- Enhancers
- Introns
- Codon optimization
- Poly A
- siRNA

## Messenger RNA (mRNA)

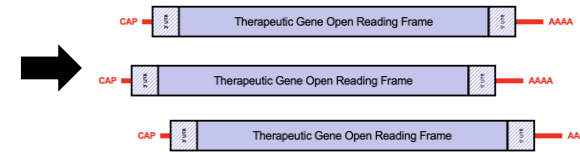

### mRNA stability

### Translation Efficiency

### Small Molecule Regulation Riboswitch Containing Cassette

### Precise dose responsive control with Oral small molecule

## Therapeutic protein

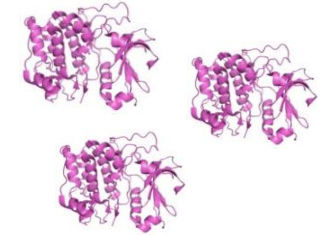

### Therapeutic protein production Levels must be:

- physiologically relevant
- safe
- consistent levels

**Drives the Efficacy of  
the product.**

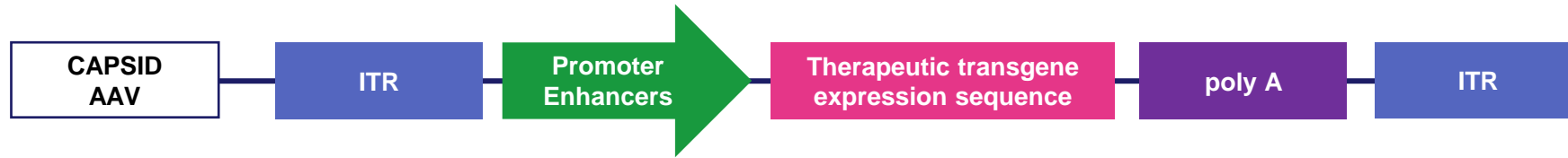

## Gene Sequence Optimization

- Promoter-enhancer-intron-exon configuration
- Codon optimization : translational efficiency, immune evasion
- Kozak sequence and Poly A optimization
- cDNA engineering/Protein Engineering – vector stability, transgene size, mini genes, increased protein activity and potency

## Gene Regulation Switch Technology

Broad gene regulation platform to overlay onto cell specific promoter control dose dependent regulation by novel small molecules at unprecedented dynamic range and dosing

## Capsid Evolution and Selection

- Capsid selection for each indication and cell type
- Tissue specific NHP screens for capsid tropism – intravitreal, front of the eye, liver, CNS and more

## Promoters

- Bespoke promoter engineering for all vector constructs
- Large scale promoter / enhancer screening programs
- AI driven promoter enhancer discovery
- Cell specificity, appropriate expression **levels drive potency, efficacy and safety**

## Manufacturability

- ITRs – packaging efficiency (and impact on vector genome transduction and expression)
- Plasmid backbone design – cap/rep organization, stuffer sequences
- Alternative transfection DNA – minicircles, doggybone, linear DNA
- Producer cell lines: incorporating gene regulation technology

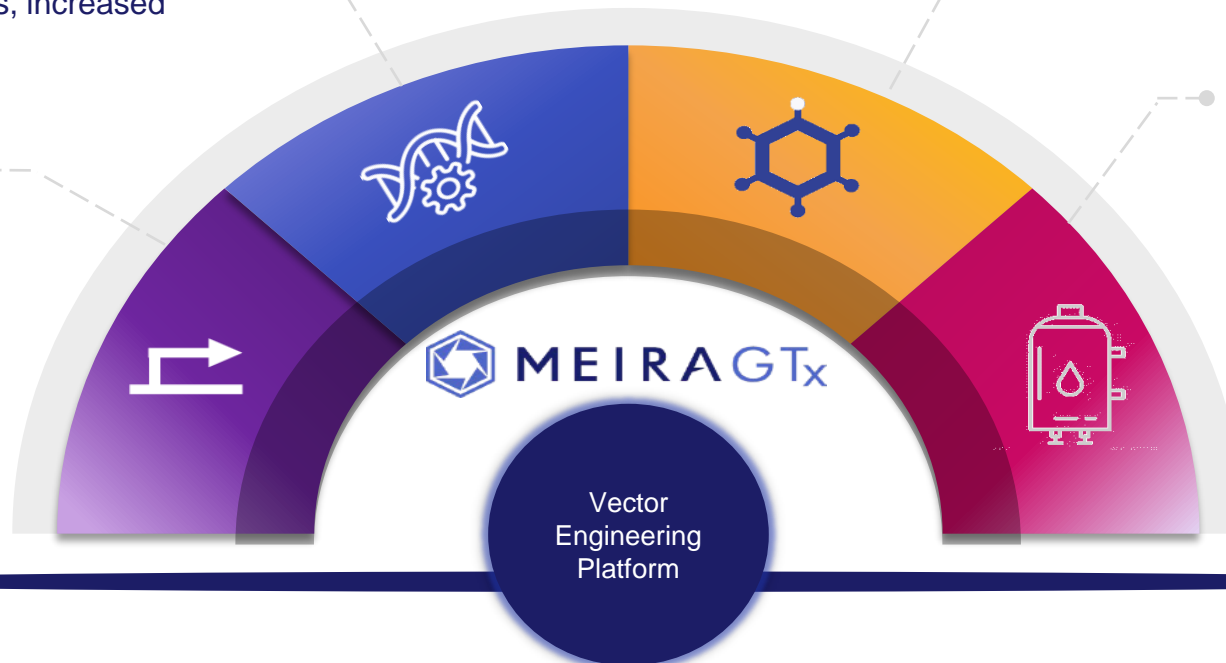



## Vector Optimization: Promoter Engineering Platforms

### MeiraGTX Promoters: Increasing Strength of Transcriptional Regulatory Elements



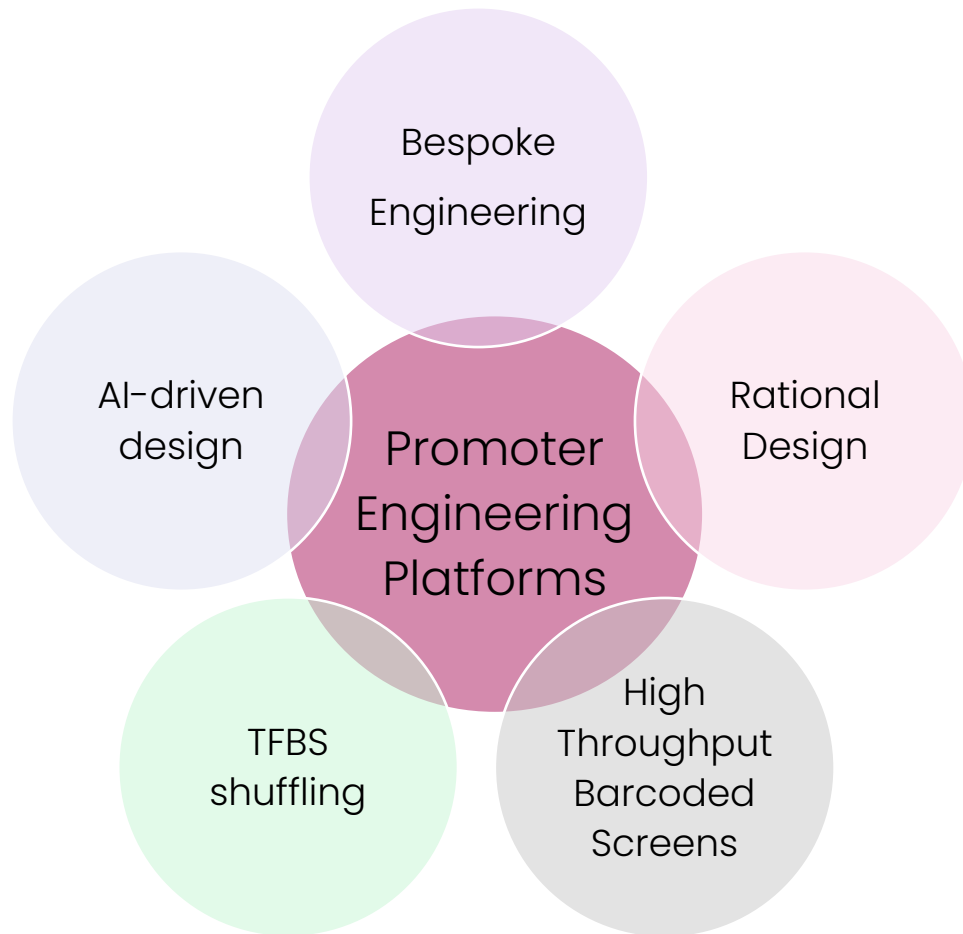

## Multiple engineering and screening strategies for design and selection of strong constitutive, tissue specific promoter/enhancer elements – driving potency and safety

- Bespoke Promoter engineering: based on cell specific promoter elements in human iPSC derived organoids
- Rational design: Screening of combinations of cis-regulatory elements (including promoters and enhancers identified from in-house as well as large public databases such as ENCODE and FANTOM)
- Generation and screening of synthetic enhancers via cell specific transcription factor binding site (TFBS) shuffling
- Barcoded NGS-based promoter screens using fragmented genomic sequences
- *In silico* screening and evolution of promoters via machine learning methods

# Bespoke Promoter Engineering Drives Differential Efficacy: Achromatopsia

Achromatopsia is a cone-specific genetic disorder in which cone photoreceptors are unable to respond to light, leading to blindness from birth caused by a mutation in one of two genes **CNGA3** and **CNGB3**

**BUT** – the ratio of the proteins is different - 1 unit of **CNGB3** and 3 units of **CNGA3** associate to form a channel that allows cones to function

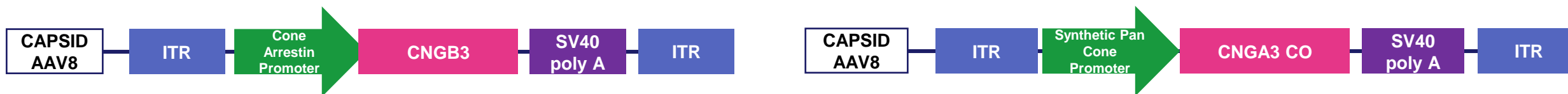

## Development of strong pan-cone specific promoter in human iPSC derived retinoids

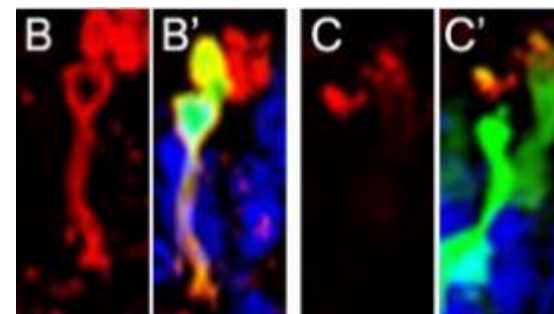
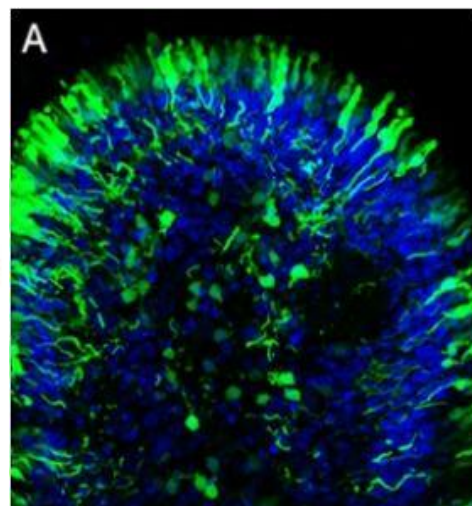
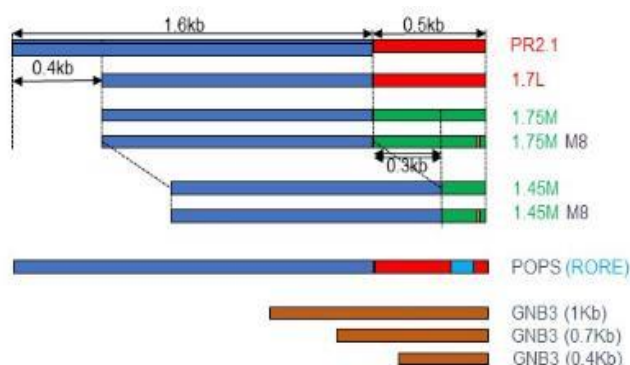

Co-localisation of blue opsin (S-opsin; B) with GFP (B') and red/green opsin (L/M-opsin; C) with GFP (C') is indicated following staining using antibodies that bind to either blue opsin (S-opsin) or red/green opsins (L/M opsin).

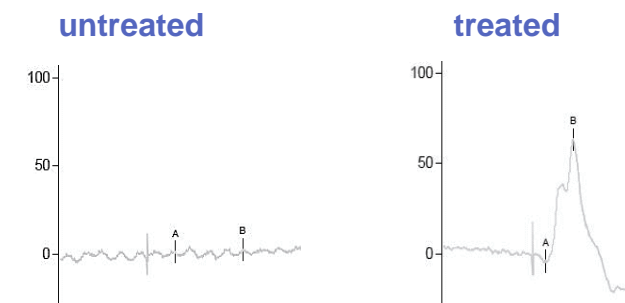

Electroretinography performed at 10cd.s.m2 after 4 weeks of subretinal delivery. 4µl of 1x10<sup>12</sup> vg/ml per retina (AAV8-hG1.7p.coCNGA3).



## Aim: Select and design promoters of small size with maximal activity, and test cell selectivity

- Design composite constitutive or tissue-specific promoters using different combinations of core promoters and cis-regulatory elements/motifs
- Include cis-regulatory elements that are either well characterized or from genome-wide RNA-seq, ATAC-seq, and ChIP-seq datasets (e.g. ENCODE, FANTOM)
- Promoter combination candidates driving a GFP reporter are tested in relevant cells with a flow cytometry assay
- More than 300 such rationally designed composite promoters are under investigation

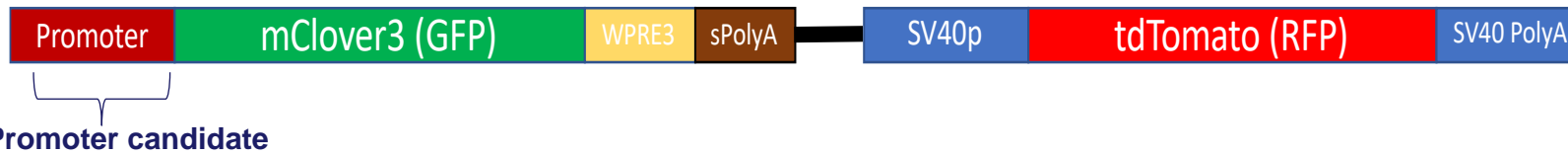

- Reporter plasmids with different promoter candidates are transiently transfected into cells
- Quantify GFP expression level in transfected (RFP+) cells by flow cytometry to identify potent promoters

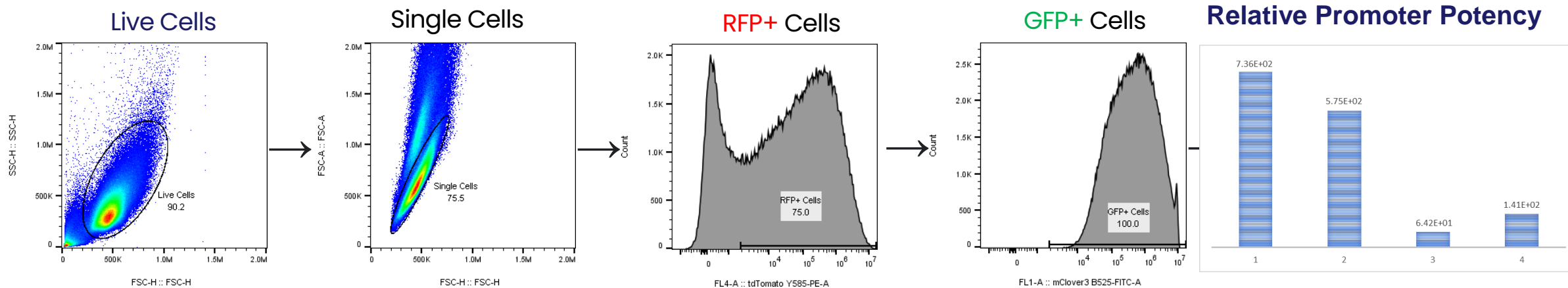

## 1. Generation of Synthetic Enhancers by **Transcription Factor Shuffling**

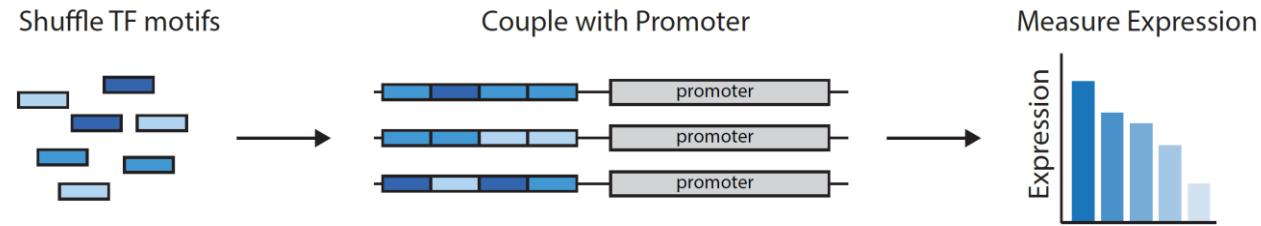

## 2. AAV-based or plasmid-based promoter screen using **barcodes**

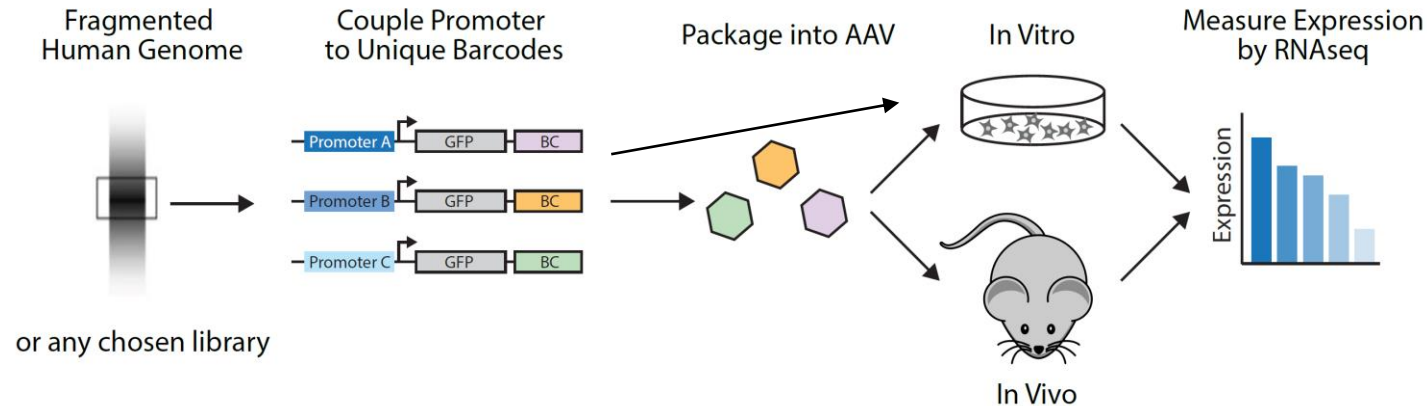

### **DNA libraries for barcoded screens include:**

- Randomly fragmented genomic DNA
- All annotated human promoters (Eukaryotic promoter database)
- All putative natural enhancers (ENCODE, FANTOM)
- Synthetic enhancers/promoters (e.g., combinatorial libraries of tissue-specific transcription factor binding sites)

# AI-driven Promoter Design and Evolution: Validated with *in vitro* testing

Using AI to identify **natural** enhancers that boost promoter strength

Train a CNN model to predict promoter activity from DNA sequences

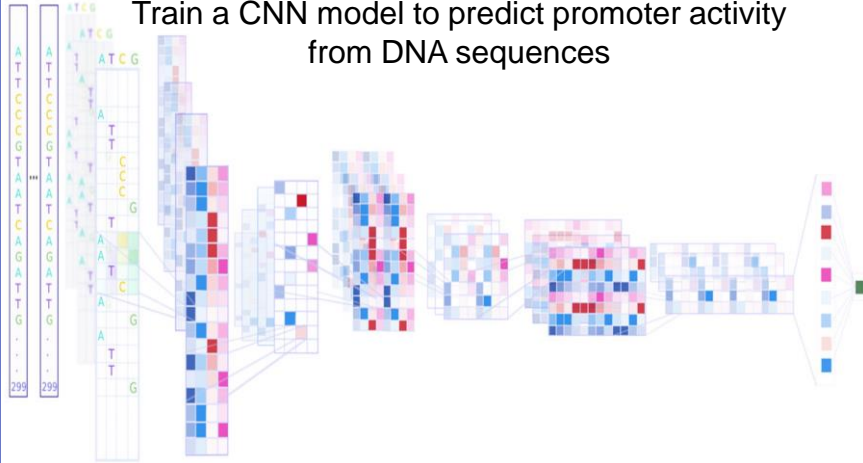

Scan 700,000+ Enhancer sequences, Predict best candidates and optimize the correct location

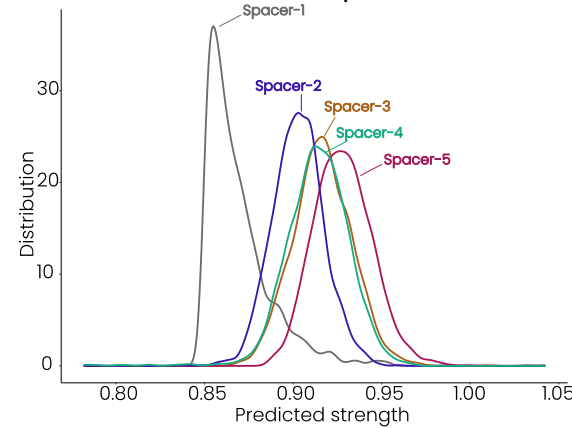

Synthesize constructs and Validate them *in vitro* (HEK293T)

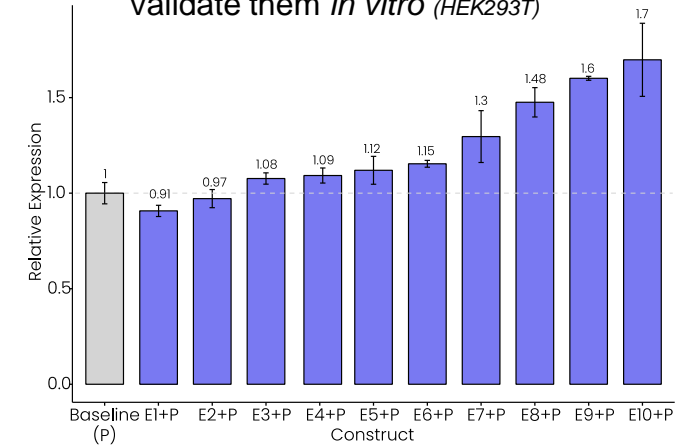

Using a **Genetic Algorithm** coupled with our AI model to evolve strong natural enhancers (n~2,000) into stronger synthetic enhancers

Evolution and selection of the fittest enhancer for each generation

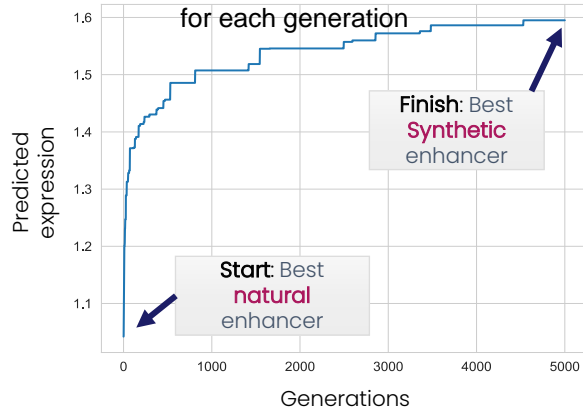

*In vitro* validation of the fittest enhancers (HEK293)

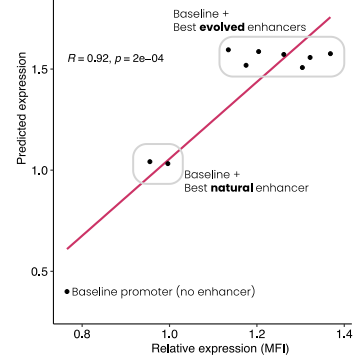

*In-silico* mutation of in-house promoters to speed up the discovery of stronger promoter variants

*In-silico* mutation of in-house promoters to speed up the discovery of stronger promoter variants

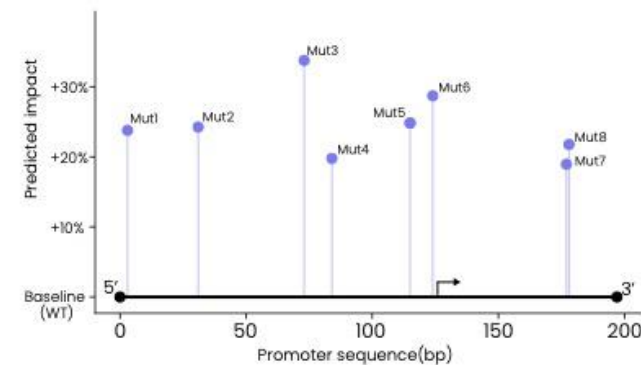

Validate *in vitro* (HEK293T)

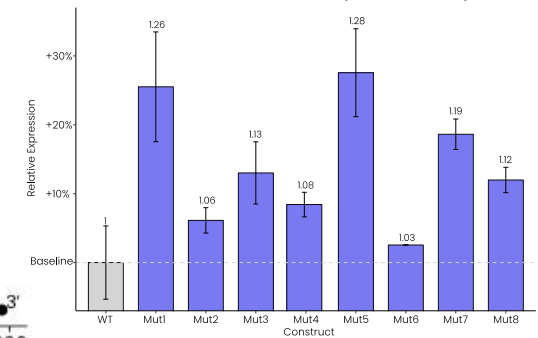



# Proprietary Constitutive Promoters Smaller and Stronger than CAG



- **CAG is a commonly used ubiquitous promoter / enhancer combination (chicken beta actin promoter, CMV enhancer), used in both approved gene therapies Zolgensma and Luxturna**
- **But it is large (1.6kb) and it is ubiquitously expressed and therefore provides no cell specificity**
- **MeiraGTx currently has 40 constitutive promoters up to 10-fold stronger than CAG**
- **Some constitutive promoters show higher expression in certain cell types compared to others – cell specific selectivity.**

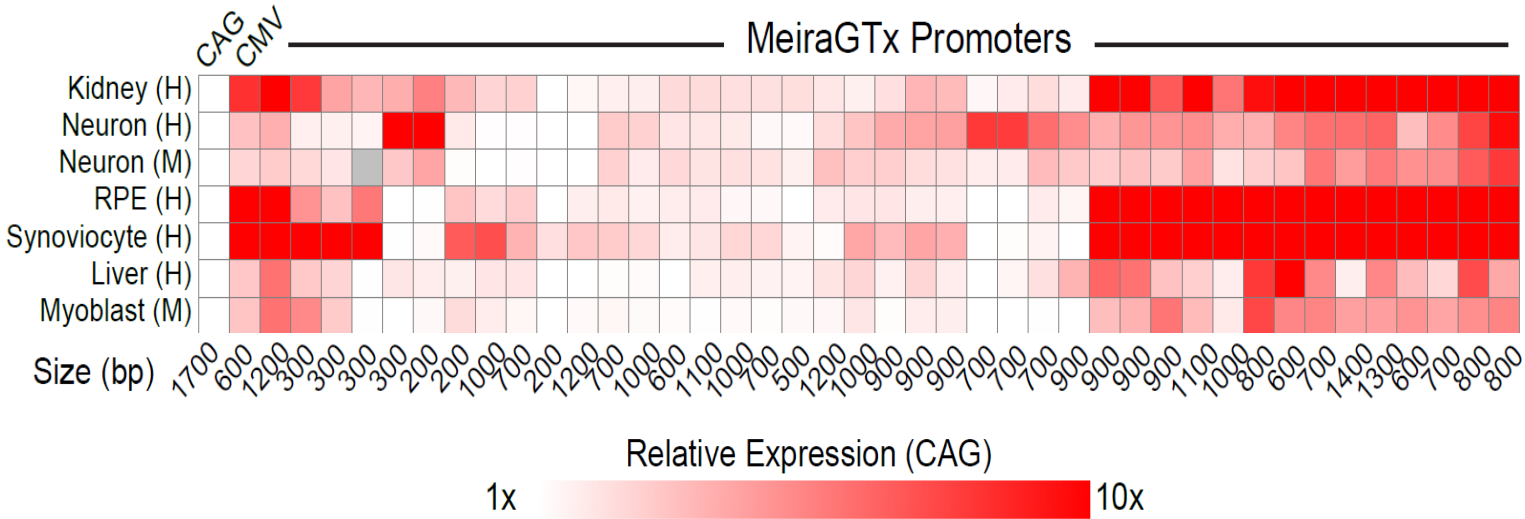

Human Kidney (HEK293)  
CAG Variants

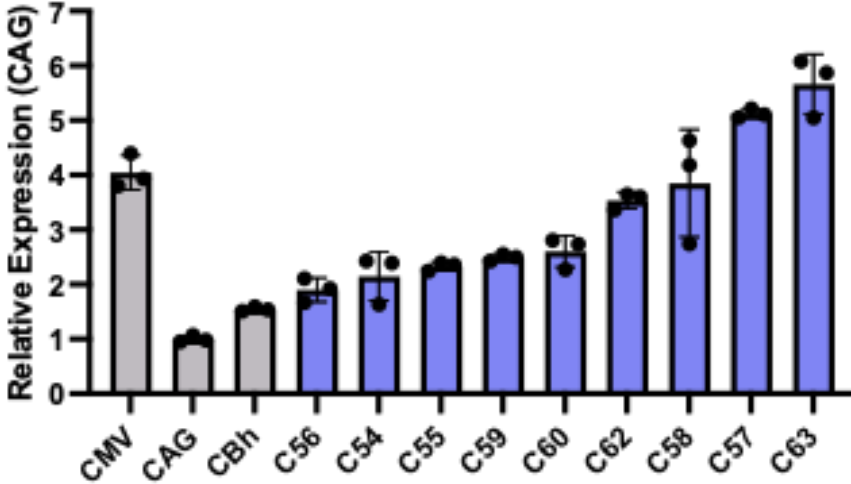

# Cell Selective Promoter-Enhancer Combinations: Neuronal and Liver

## CNS Promoters

10+ promoters that are up to 12x stronger than CAG in both human and mouse neuronal cell lines

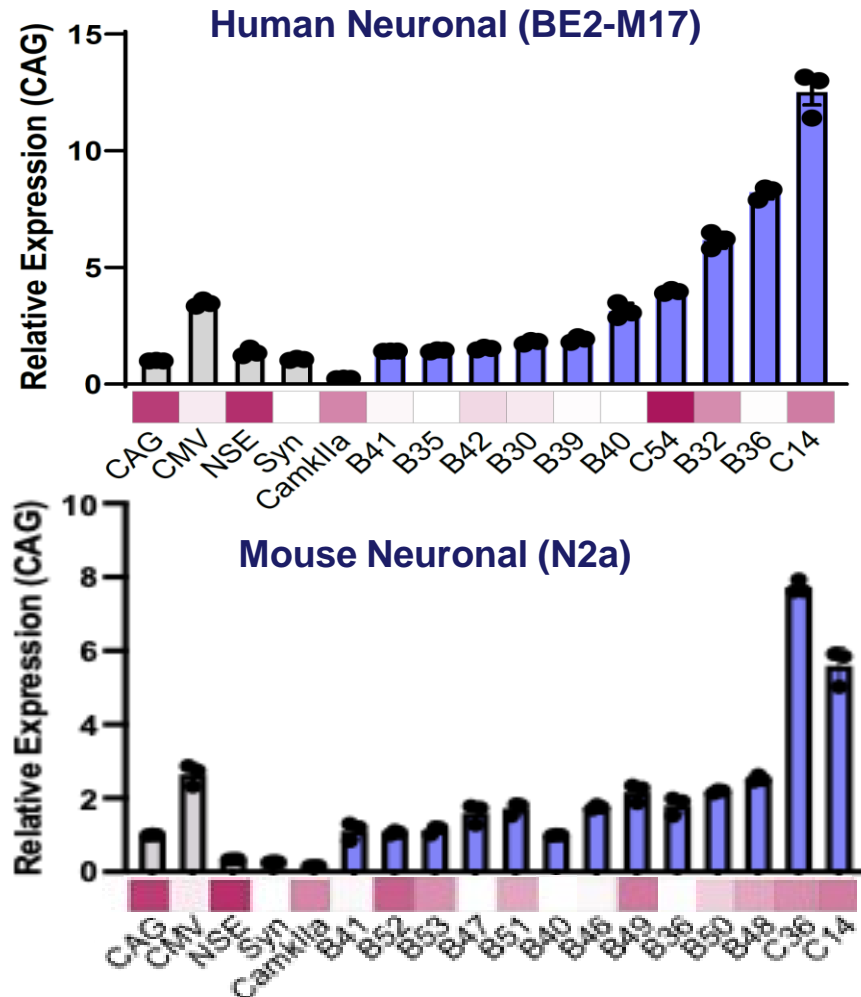

## Liver Promoters

13 liver-specific promoters that are up to 4-fold stronger than CAG and stronger than promoters currently used clinically (AAT, LP1, TBG). All smaller than CAG.

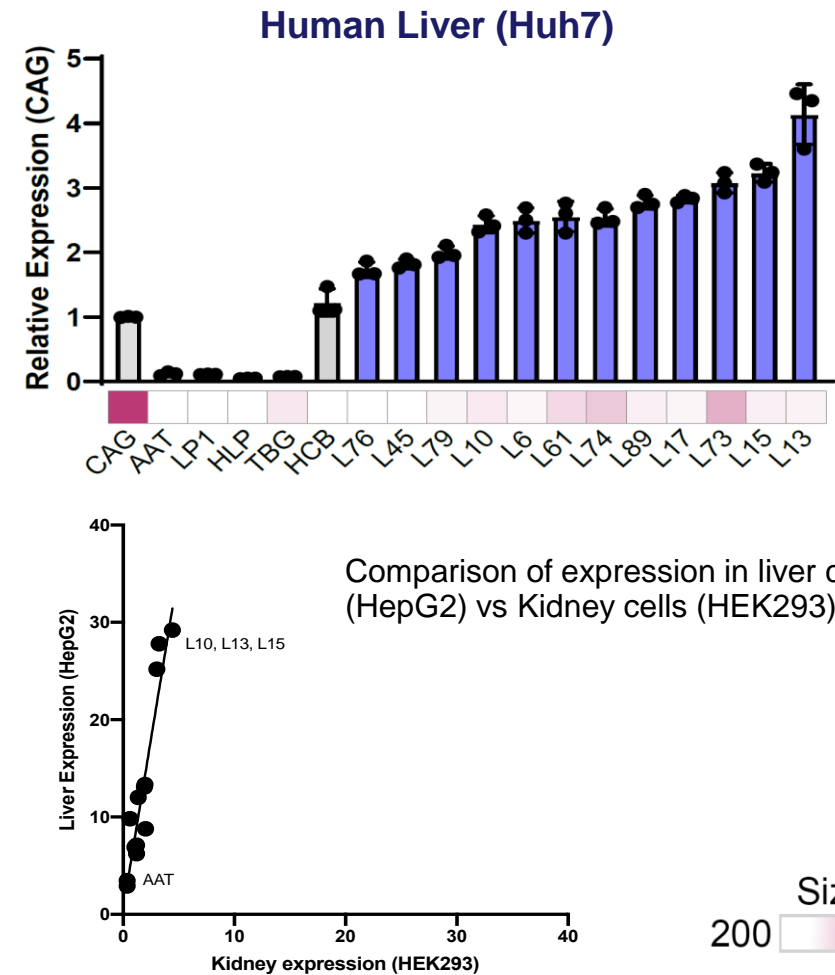

# Strong and Small Muscle Selective Promoters: *in vivo* Validation

9 muscle-specific promoters that are stronger than tMCK which is currently used in clinical trials

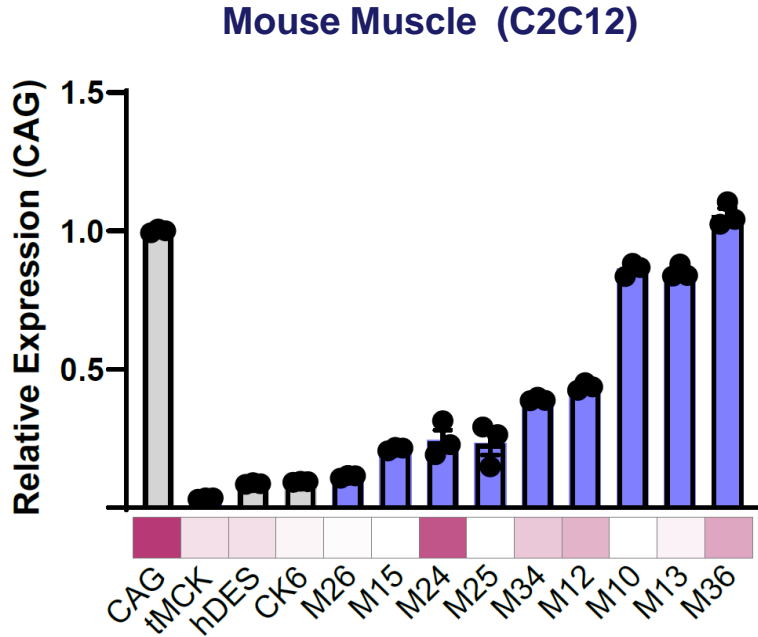

A muscle-specific promoter is 17-fold stronger than tMCK in mouse muscle *in vivo*

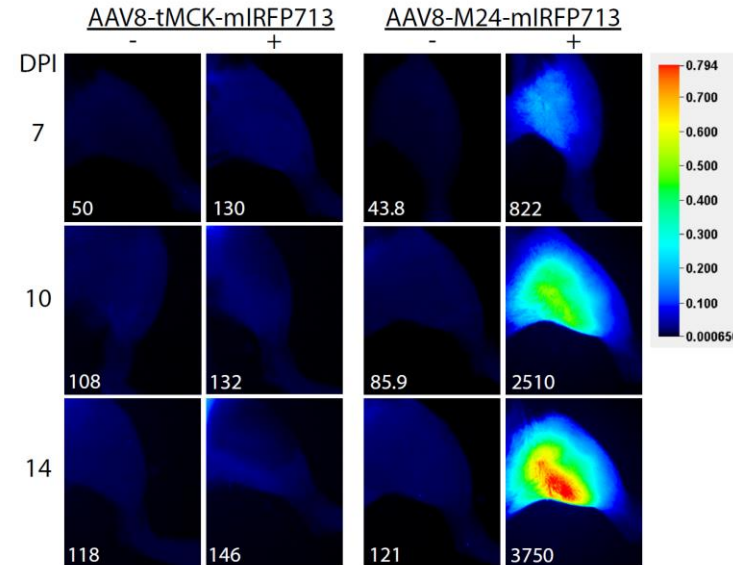
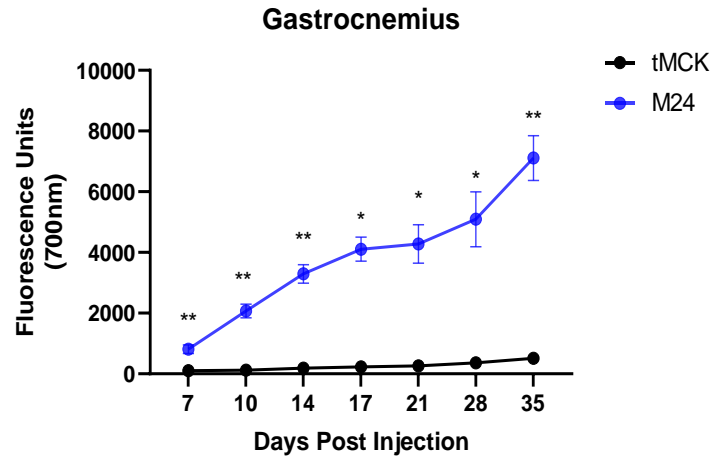

A small 751 bp ubiquitous promoter is stronger than CAG in the muscle

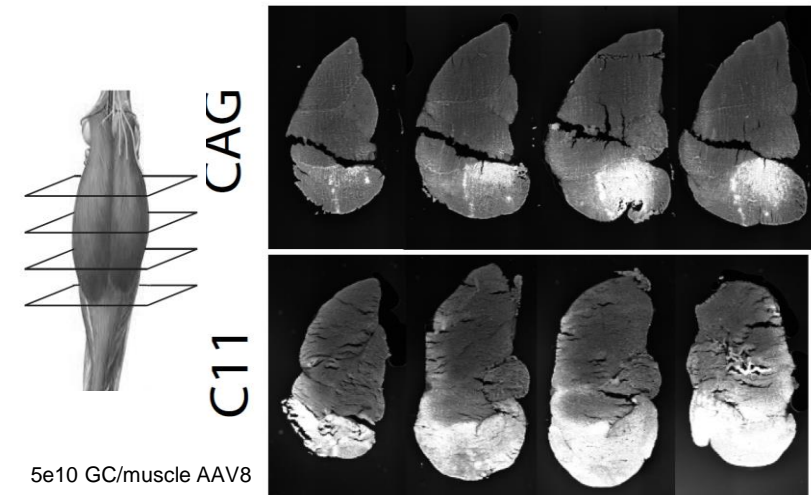
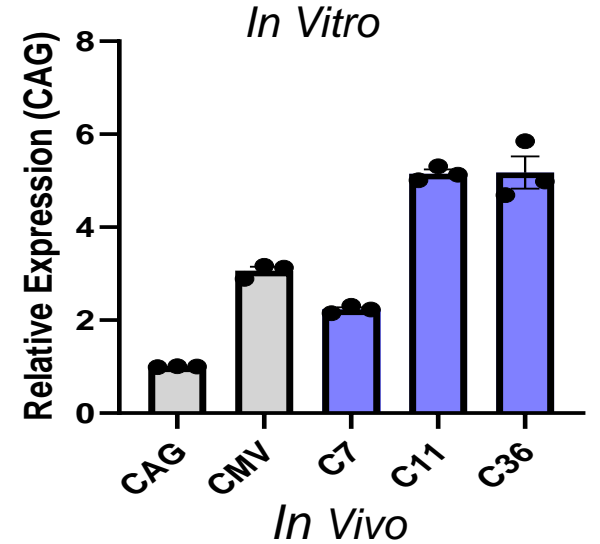



# SUMMARY: Multiple Promoter Engineering Platforms Creating Libraries of Strong, Small Tissue Selective Promoters-Enhancer Combinations

Multiple engineering and screening strategies for design and selection of strong constitutive, tissue specific promoter/enhancer elements – driving potency and safety

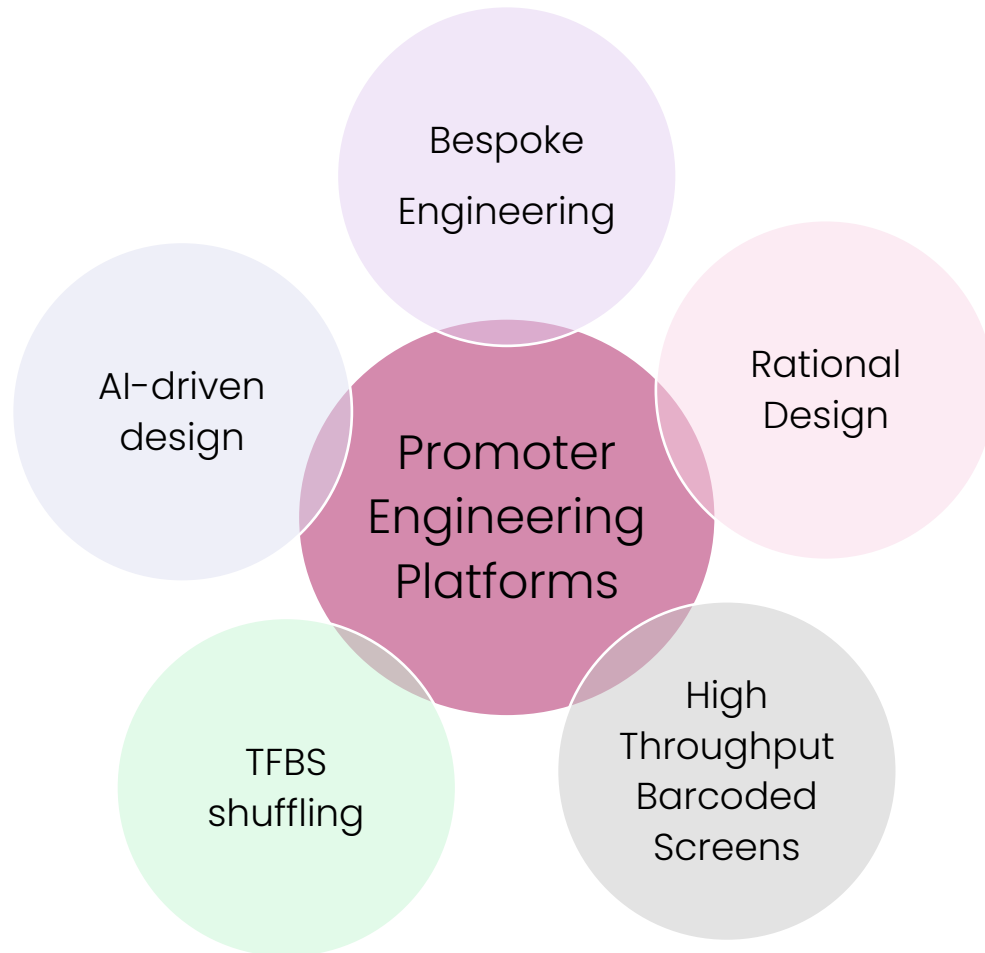

Libraries of synthetic novel promoters with smaller size, greater strength and cell selectivity compared to CAG, CMV and cell specific promoters; ongoing optimization of library to increase the promoter toolkit

- Multiple cell specific promoters for all of the different cell types in the eye for different levels of expression: e.g., the strongest known human pan-cone promoter
- 40 constitutive promoters up to 10-fold stronger than CAG and/or CMV
- 10+ neuronal promoters up to 12x stronger than CAG in both human and mouse neuronal cell lines
- 13 liver-specific promoters up to 4-fold stronger than CAG and stronger than promoters currently used clinically (AAT, LP1, TBG). All smaller than CAG.
- 9 muscle-specific promoters that are stronger than tMCK (which is currently used in clinical trials)
- A synthetic muscle-specific promoter is durable and >17-fold stronger than tMCK in the mouse muscle *in vivo*
- A 751 bp ubiquitous promoter is stronger in muscle than CAG
- *In silico* screening and evolution of promoters via machine learning methods further enhances potency and cell specificity of promoters identified by other methods

# Riboswitch Gene Regulation Platform



# Oral Small Molecules Precisely and Specifically Control Gene Therapy Activity

## For the first time, a Gene Regulation System that precisely and specifically controls the activity of genetic medicines using orally dosed pills

- ❖ It is not just an 'on' / 'off' switch but a system for dose response of gene therapies to oral drugs
- ❖ Gene regulation at **unprecedented high dynamic range of >5000**
- ❖ Any gene, any vector; cell therapy, gene editing can be controlled with this system
- ❖ With vectorology and gene regulation toolkit we can rapidly build new regulated genetic therapies
- ❖ Multiple Regulation Cassettes optimized for each gene
- ❖ Libraries of small molecules specifically designed to match synthetic aptamers, with different drug properties
- ❖ Potential for a different small molecule to precisely regulate each specific gene
- ❖ Drug characteristics (PK, metabolism, distribution) tailored to that gene and that indication

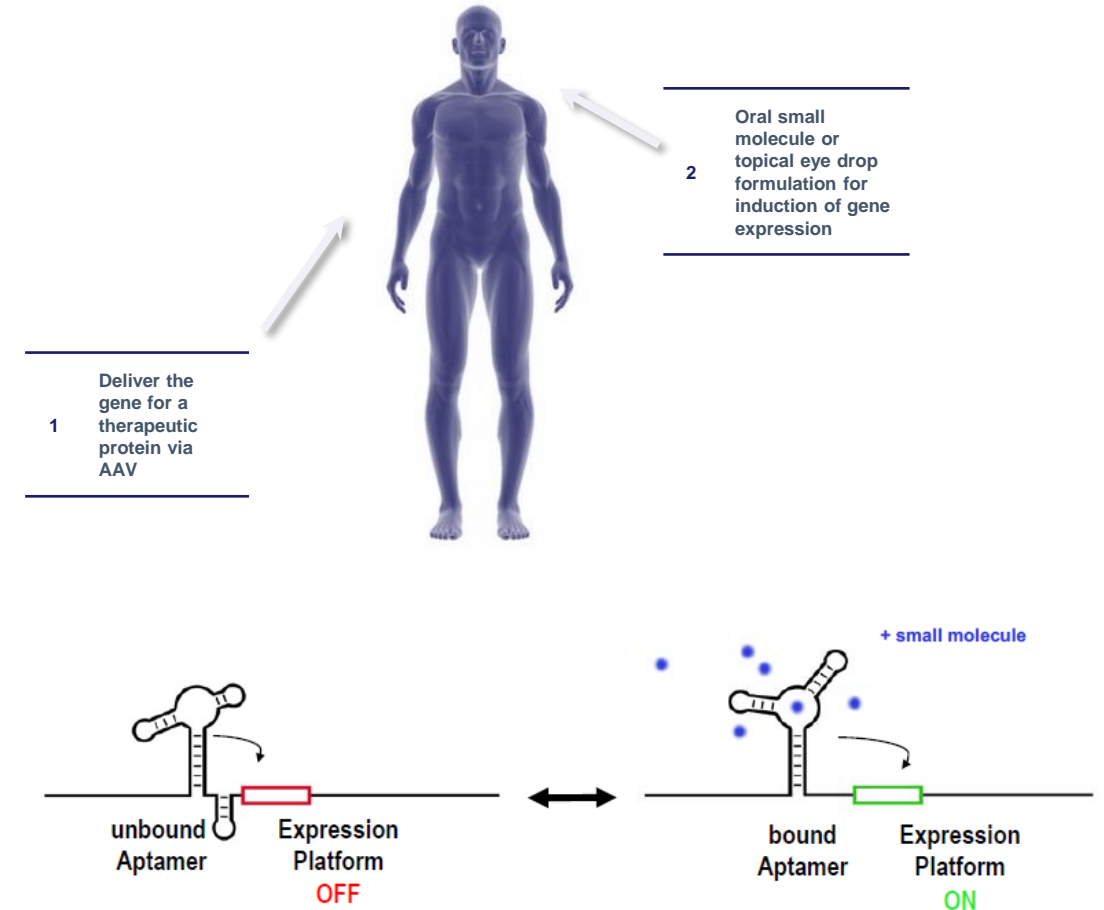

**Unique technology transforms the field of genetic medicine and delivery of biologics**





## Vectorized Biologics

We can not only vectorize and optimize viral vectors for expressing Antibodies and other therapeutic proteins – but we can precisely control their expression: rare disease gene replacement consistency of dosing or systemic Vectorized Antibodies  
Improved **Safety** and Consistency of dosing between patients



## Passive and Active Vaccines with built-in capacity for Oral Small Molecule Boosters

**Active Vaccine:** regulated vaccine mRNA can be boosted multiple times any time after first IM delivery as needed with an oral pill

**Passive Vaccine:** neutralizing antibodies activated systemically and durably as needed with an **oral pill** e.g., COVID-19, universal flu



## CNS expression of biologics – across the BBB

Potential to address one of the biggest challenges in medicine: getting large molecules across the blood-brain-barrier  
Gene Therapy delivered 1x within the BBB and activated using a small molecule that crosses the BBB



## Short-lived Therapeutic Hormones and Peptides

Precise activation of naturally short-lived peptides and hormones using an oral pill; and allows for combinations of multiple natural peptides regulated together.



## Ocular expression of therapeutic proteins

Tight control of expression of therapeutic proteins in the eye with eye drop formulation of small-molecule inducer; improved safety and new targets



## Gene Editing

Tight regulation of nucleases targeting DNA or RNA e.g., Cas9 and CasRx



## Cell Therapy

Controlled expression of CAR, 'Kill switches'; both 'on' and 'off' switches



## Pricing of Gene Therapies

Pay for the pill which delivers the active therapeutic protein, not just the 1x delivery of the gene therapy

# MeiraGTx Riboswitch Driven Gene Regulation Cassette

## We created a Gene Regulation Cassette controlled by a Riboswitch

- Promoters and transcriptional regulatory elements are absolutely critical in determining the potency, efficacy and safety of gene therapies.
- We have developed a gene control system that retains all of that promoter driven control and overlays a temporal control driven by an oral small molecule.
- Dynamic range is unprecedented >5000 fold, high expression when on, low expression when off
- This system uses RNA Shape to turn gene on and off
- Gene Expression is controlled via Small Molecule RNA interaction
- Gene Regulation Cassette is incorporated into the cDNA sequence of the gene therapy vector genome
- When the DNA containing the cassette is transcribed to RNA the transcript takes on a configuration that results in complete RNA degradation
- When a specific small molecule binds to a small aptamer region within the cassette – the RNA shape configuration changes and the entire cassette is cut out and a mRNA is formed
- The mRNA produced in this way is identical to that produced by the gene therapy cDNA without the cassette - as if the cassette was never there – a perfect copy of the gene therapy mRNA

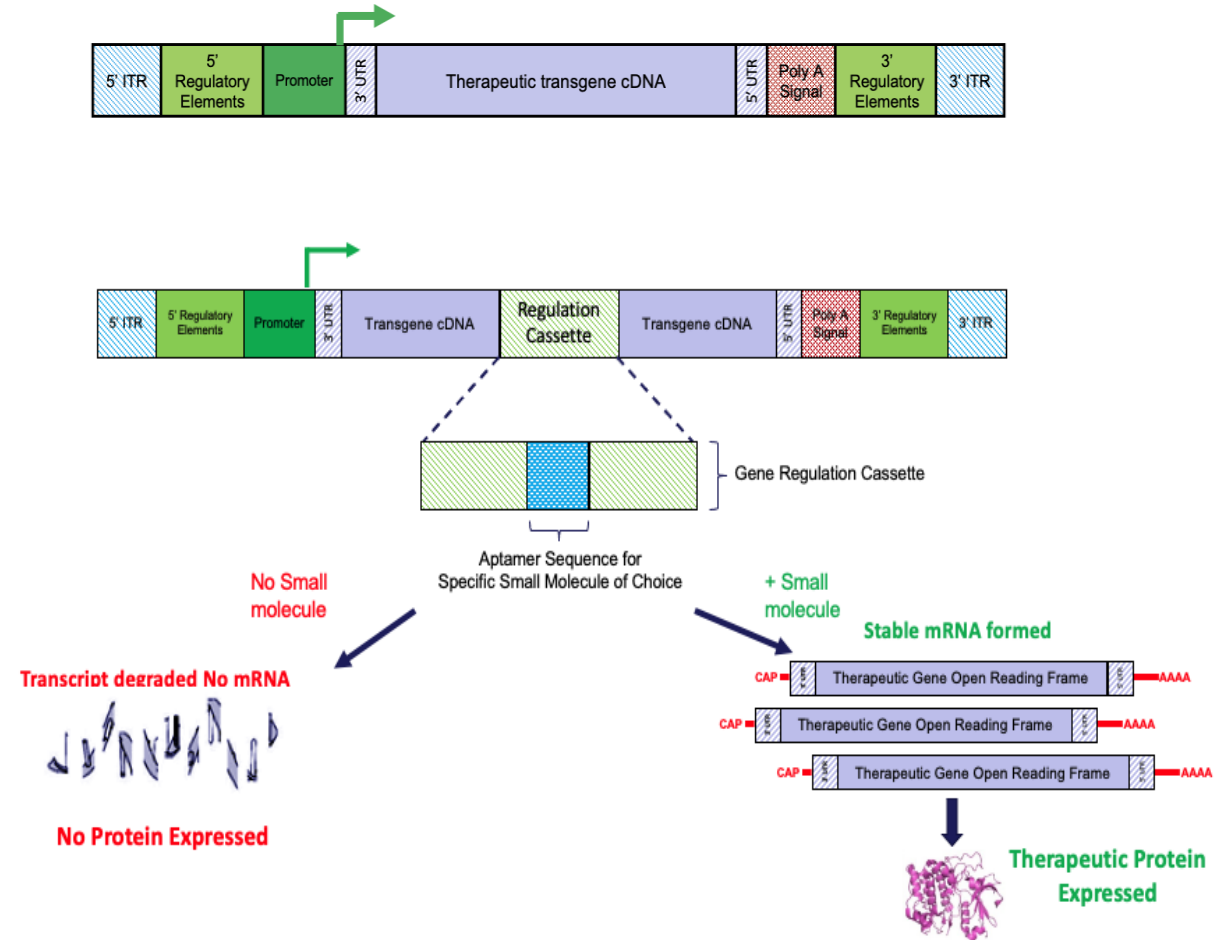

# What is a Riboswitch?

Riboswitches are Widely Used in Bacteria; no mammalian riboswitches have been identified

## What comprises a Riboswitch

- **Aptamer:** RNA sequence that specifically binds a particular small molecule
- **Expression Platform:** RNA sequence that has a particular function
- Binding of the small molecule to Aptamer alters the RNA shape and drives a change in expression platform function

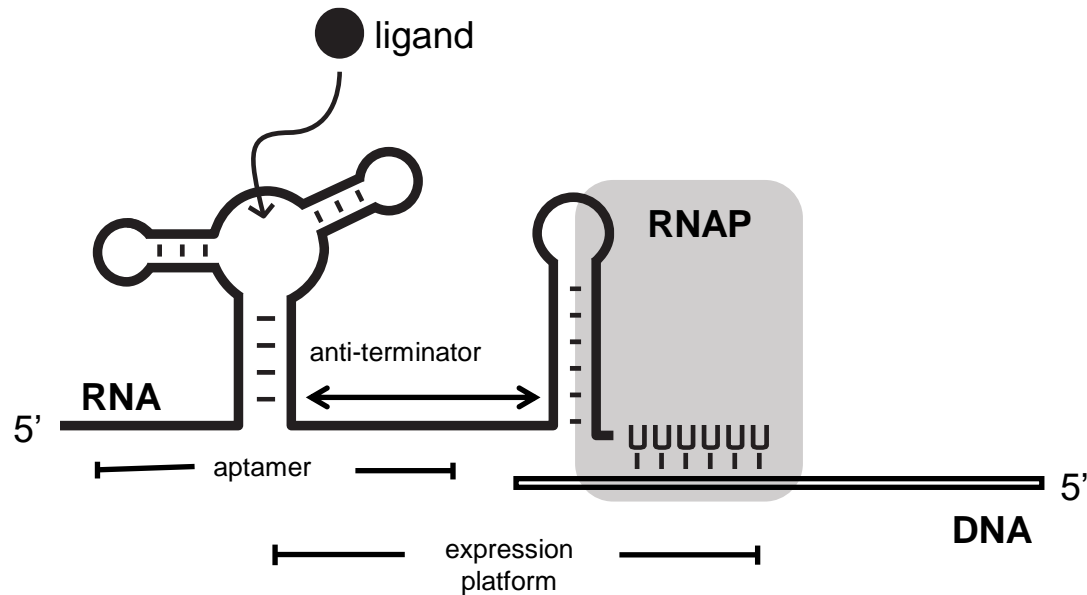

R. Breaker. *Molecular Cell*, v43, p867.

## Example: S-adenosylmethionine metabolism in *B. subtilis*

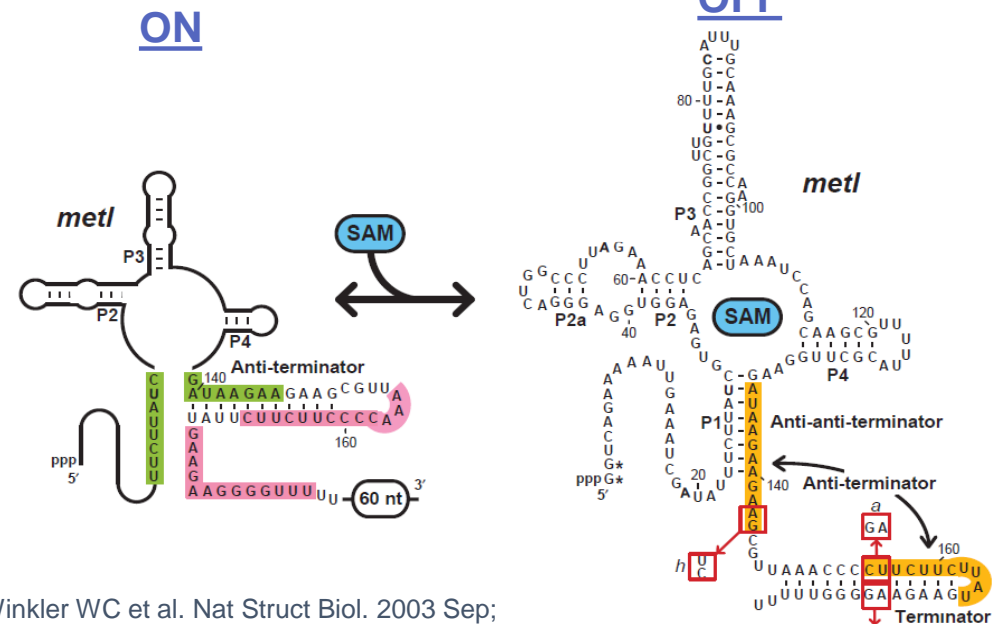

Winkler WC et al. *Nat Struct Biol*. 2003 Sep;



## Riboswitch-mediated Modulation of alternative splicing

No Small molecule  
(OFF state)

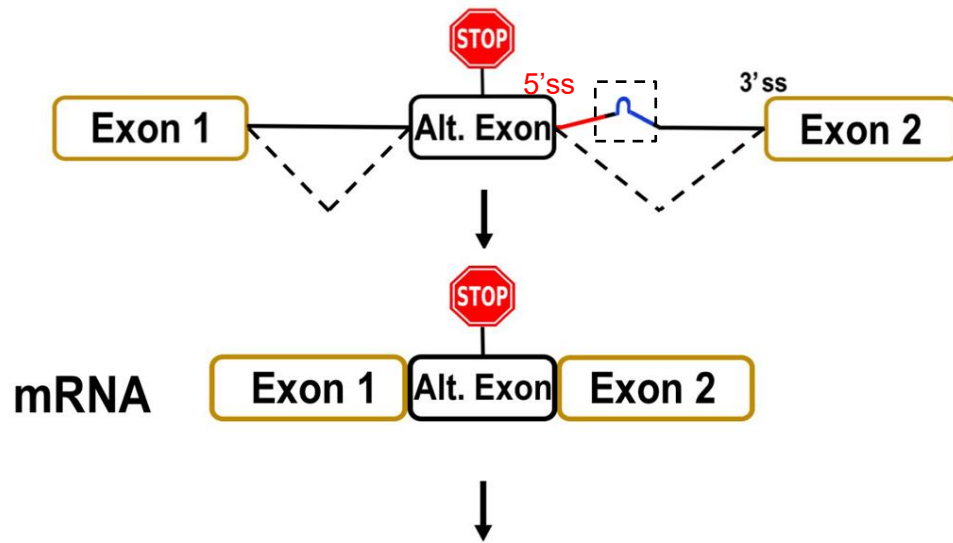

no protein

+ Small molecule  
(ON state)

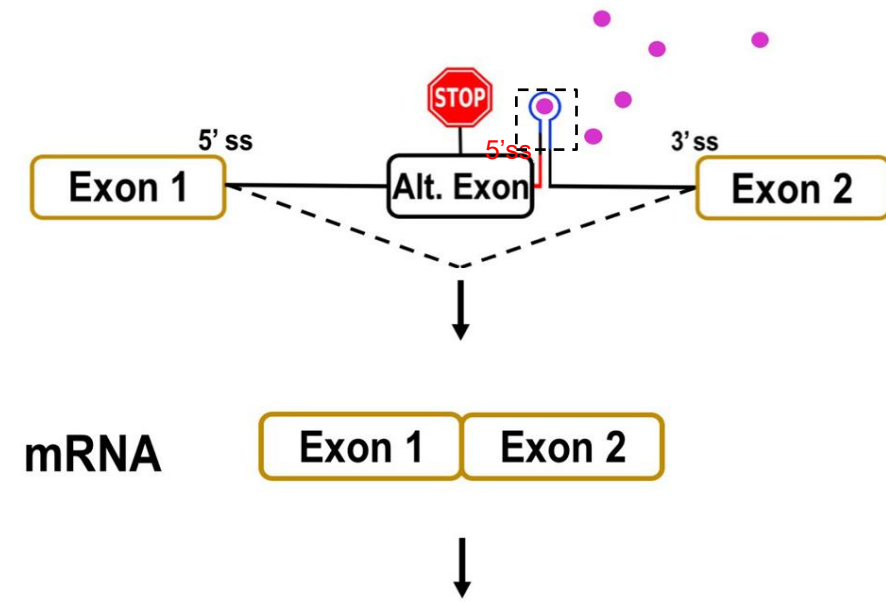

protein expressed



# Dynamic Range and 'ON' state Expression Levels Change with Different Stem Lengths

## Optimization of the Length of Stem connecting aptamer and expression platform to respond to small molecule binding

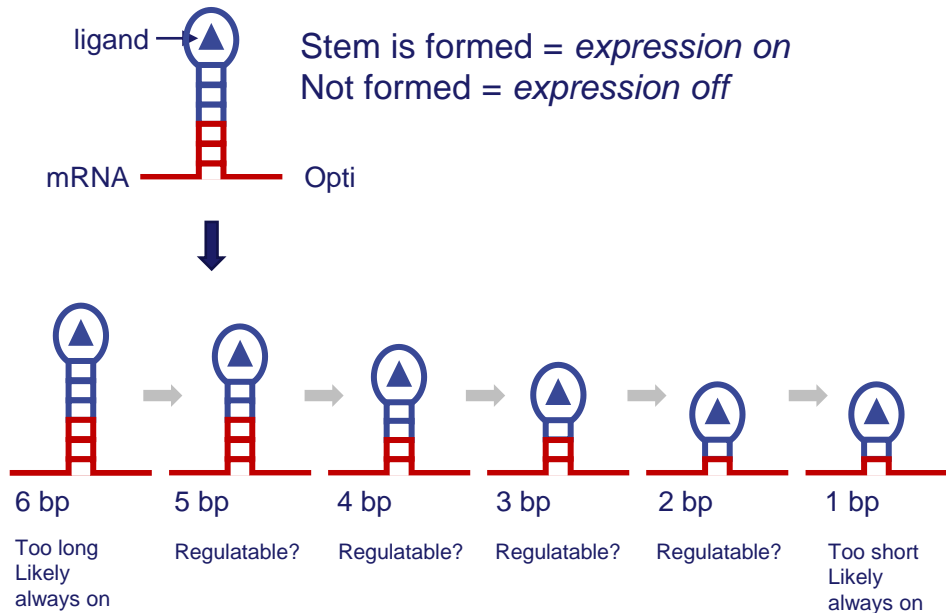

## Serial deletion of hairpin length to produce functional splicing cassette

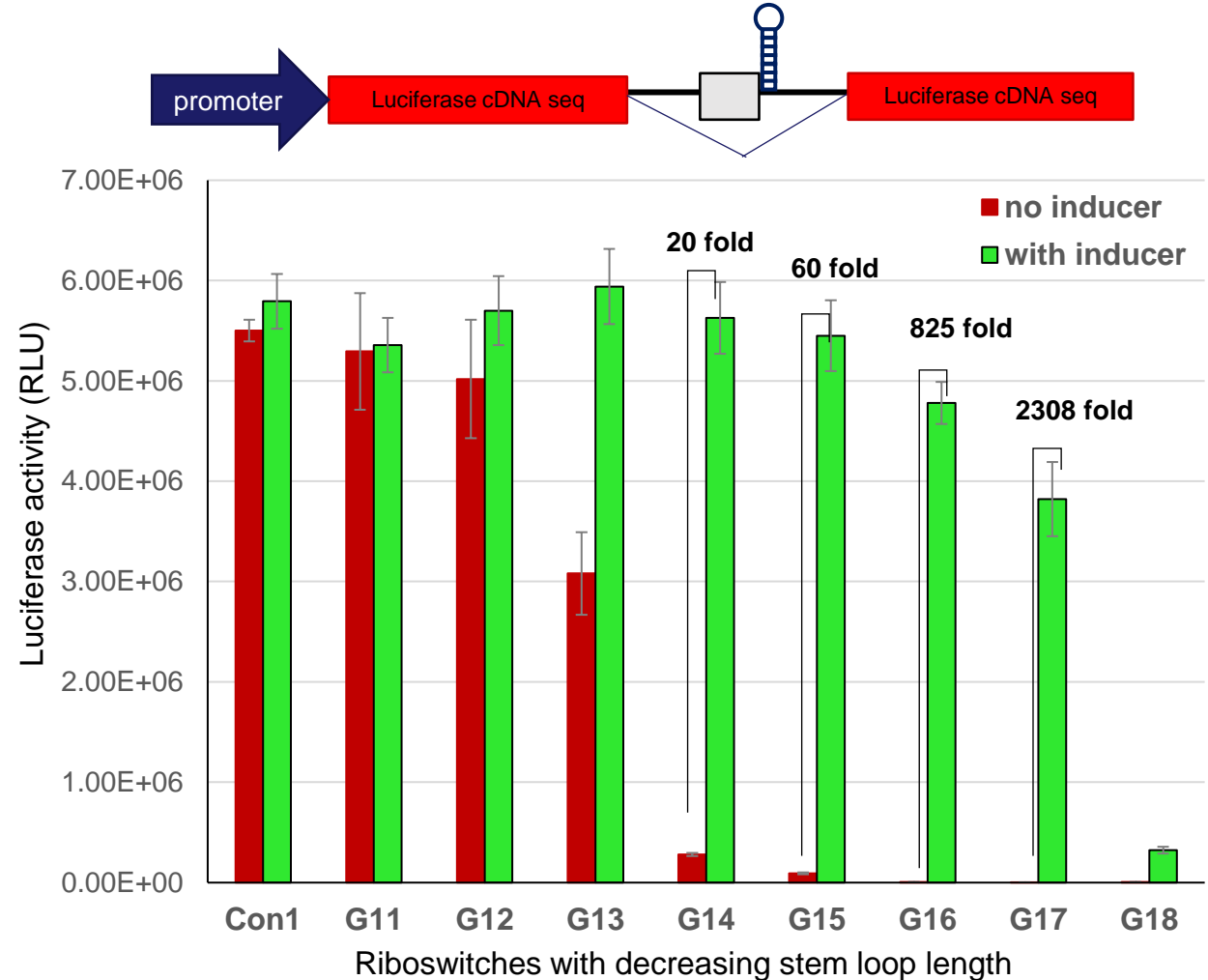

# Dynamic Range of Riboswitch can be further Optimized by Deletions in Intronic Regions

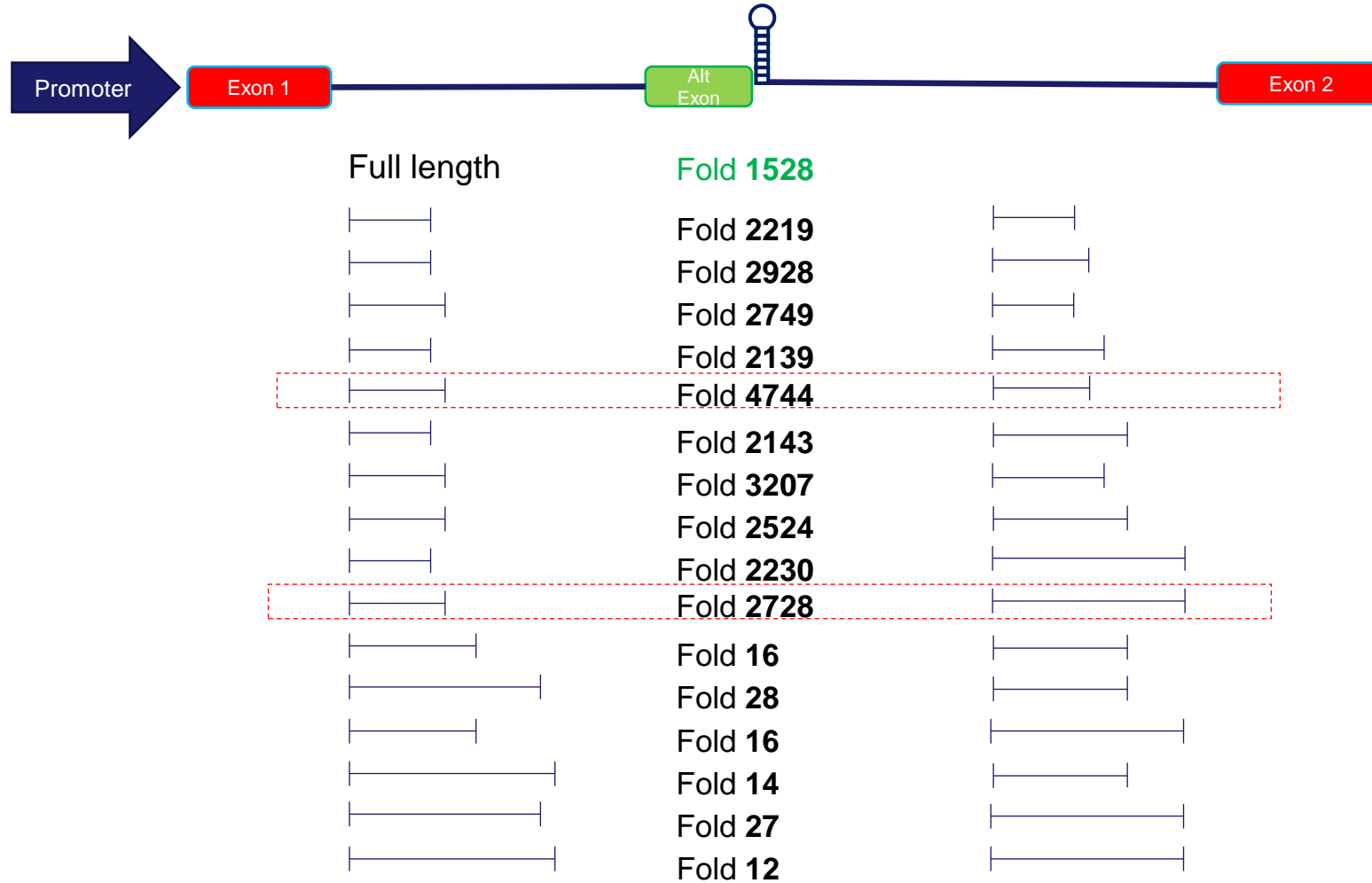



# Optimization of Intron Size and Sequence: Modulates Expression Levels and Dynamic Range

## Deletion series of intron sequences



### % induction compared to un-regulated control

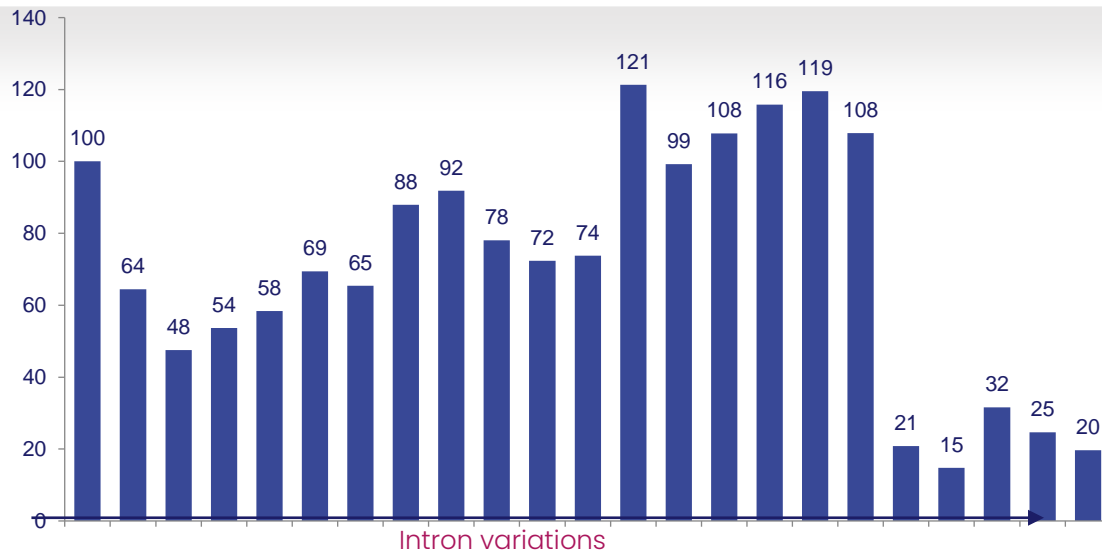

### Fold induction compared to un-induced control

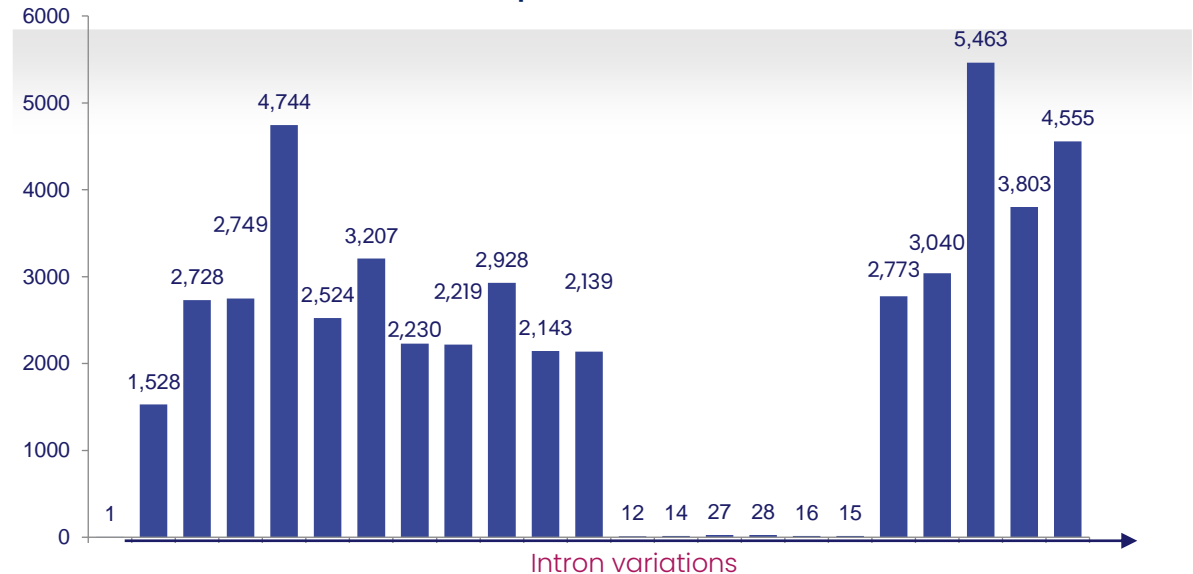

# Splicing Cassette with Mammalian Riboswitch creates a Tight 'on' Switch in Response to Small Molecule Inducer

High dynamic range: low 'off' expression; high 'on' expression  
 Different switches with different dynamic ranges

The on status of EGFP expression in the presence of inducer

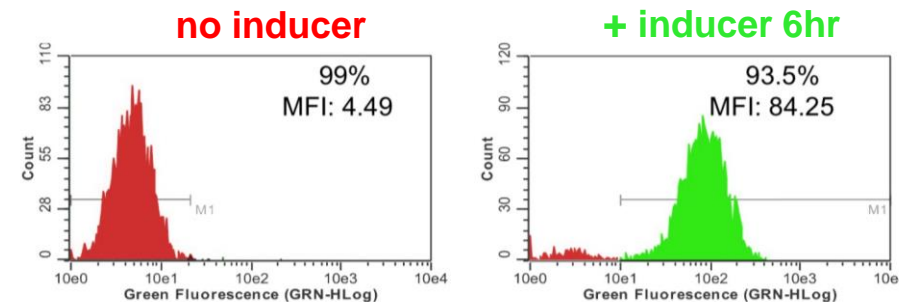

The off status of EGFP expression in the absence of inducer

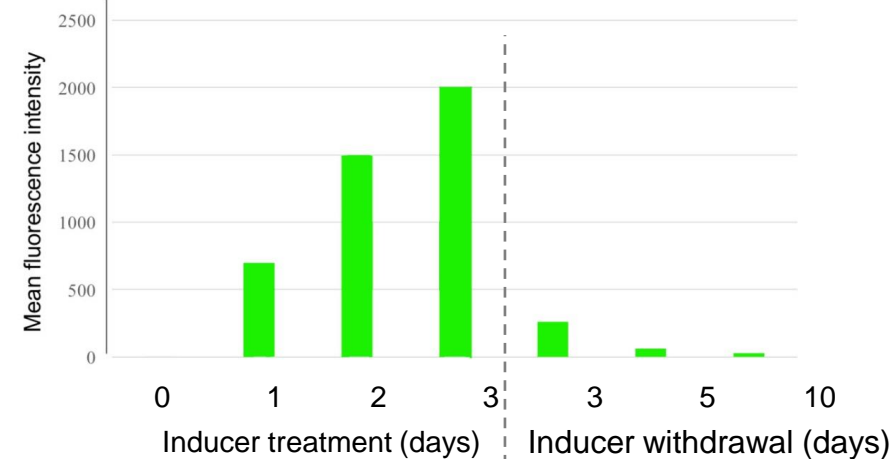

EGFP- unregulated      EGFP- G17      EGFP- G15      EGFP- G17 + 15

No Inducer

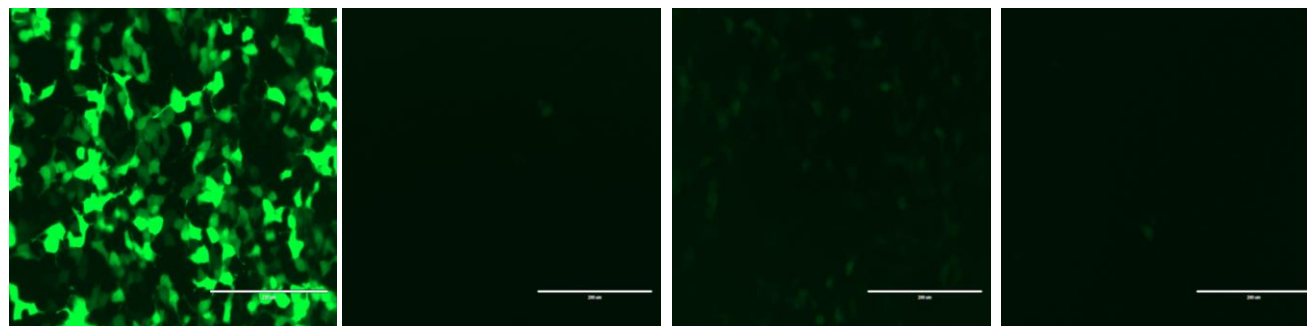

+ Inducer

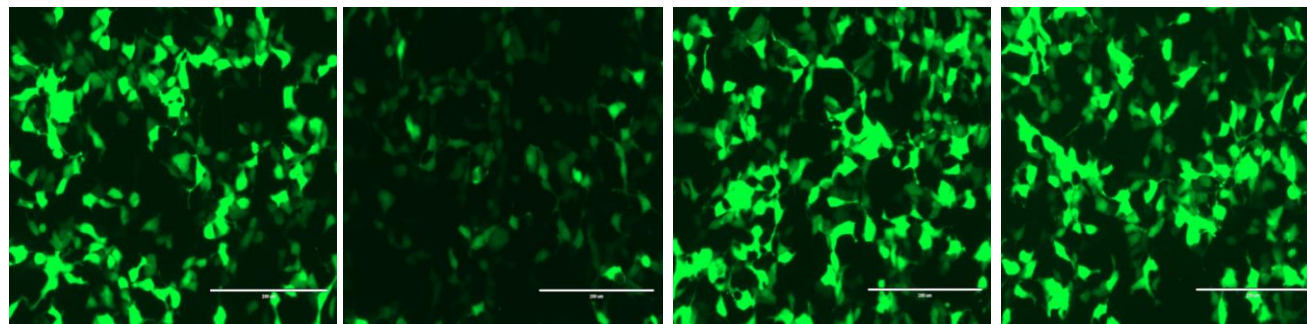

# Mammalian Riboswitches Acting via Different RNA Functions

MeiraGTx has built riboswitches that use different RNA functions (expression platforms), not only the splicing riboswitch

Both off and on switches have been built

- Aptamer-modulated RNase P cleavage of mRNA
- Twister ribozyme-based aptamer riboswitch
- Aptamer-modulated U1 interference in 3'UTR
- Aptamer-modulated polyadenylation process

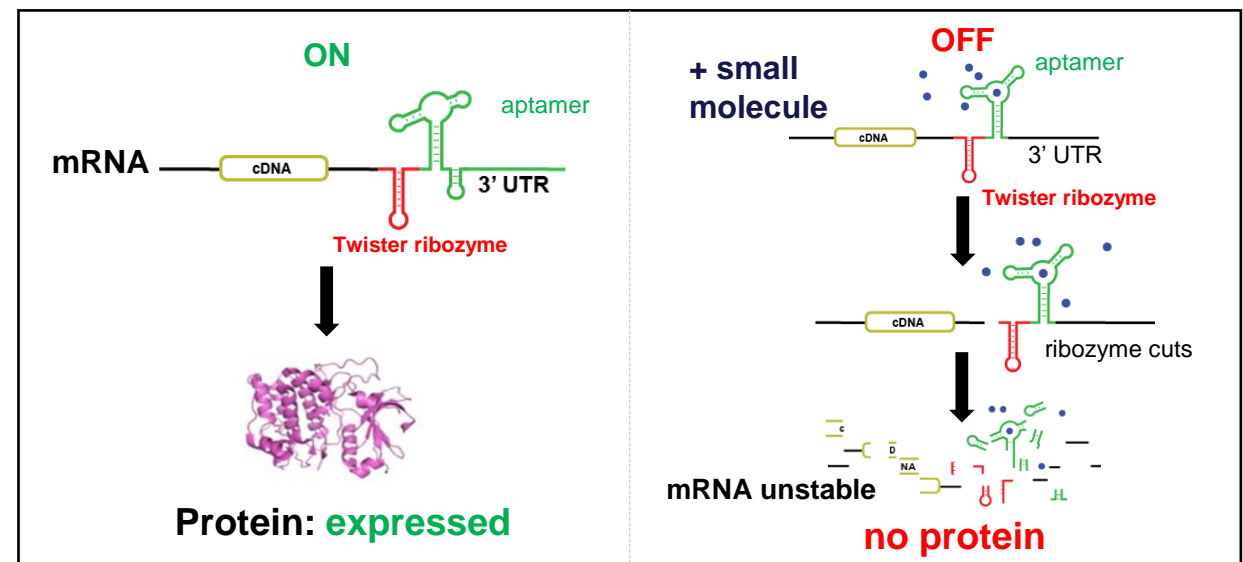
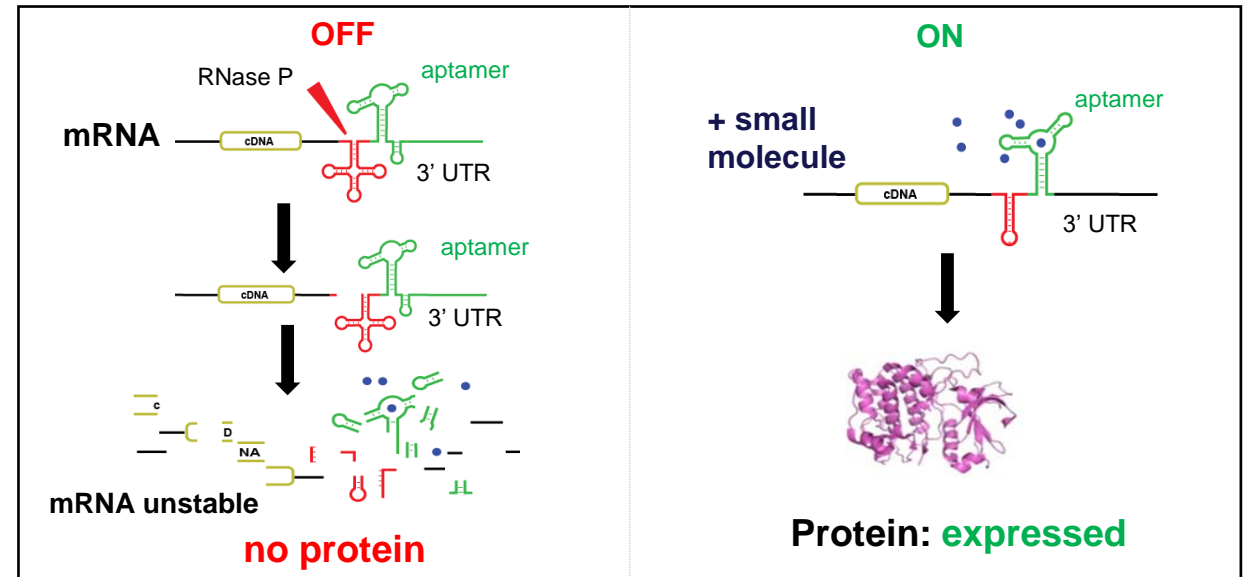



# Combining Riboswitches Increases Stringency

Combined use of Splicing-based riboswitch and RNase P cleavage-based riboswitch doubles dynamic range

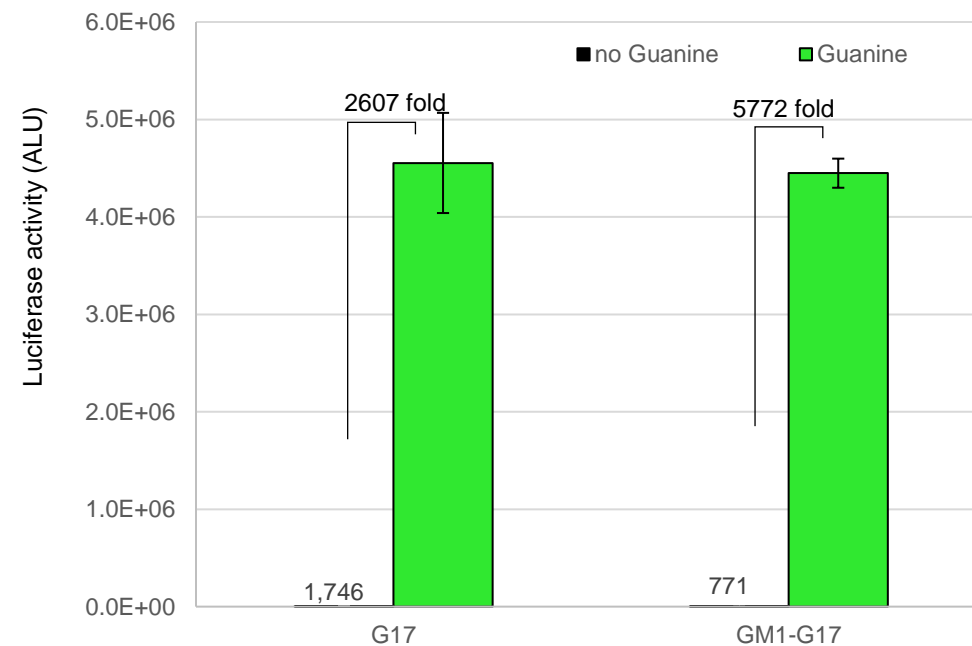
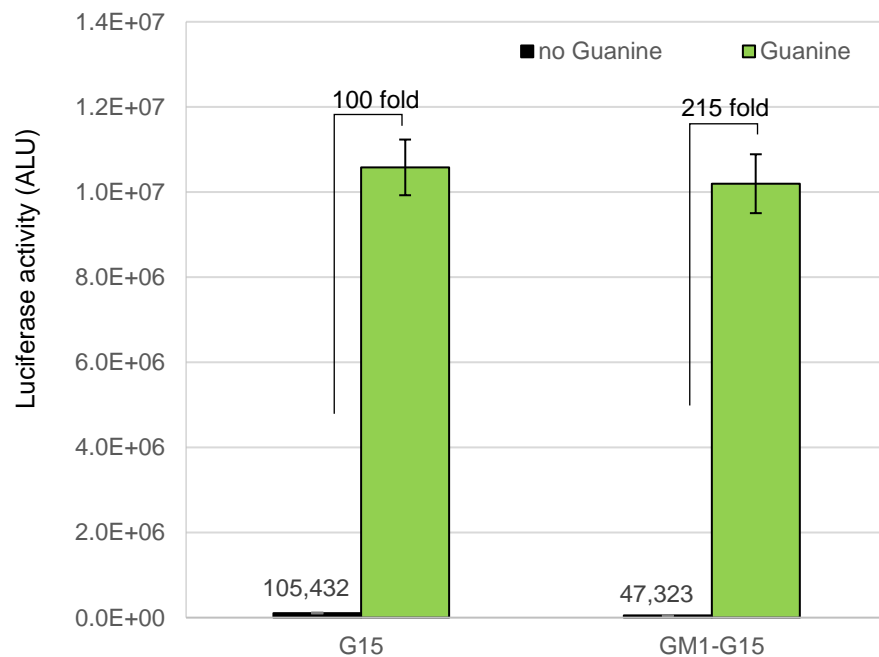
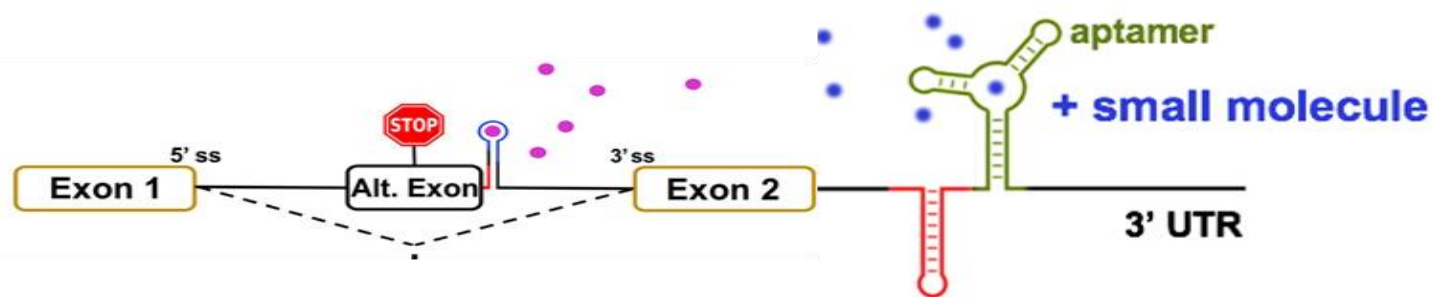

# SUMMARY: Regulation Cassette System Containing Synthetic Mammalian Riboswitch

- Rationally designed 'gene regulation cassette' active in mammalian cells
- Regulation cassette driven by synthetic mammalian Riboswitches
- Small molecule binding drives hairpin formation, drives correct transcript splicing
- **No Inducer:** RNA degradation
- **Inducer present:** stable mRNA and protein expression
- Unprecedented dynamic range of **>5000-fold**

## **We have a robust patent estate for our entire gene regulation cassette system:**

We have IP on the splicing cassette, combining switches, and on other forms of switches

Our patent application on the splicing platform has issued patents in several jurisdictions (including US, Europe, China, Japan and Eurasia) with very broad claims



# Aptamer Small Molecule Evolution





# The Small Molecule Binding Aptamer in the Regulation Cassette is Interchangeable

Riboswitches generated with different aptamers function within the regulation cassette to control gene expression

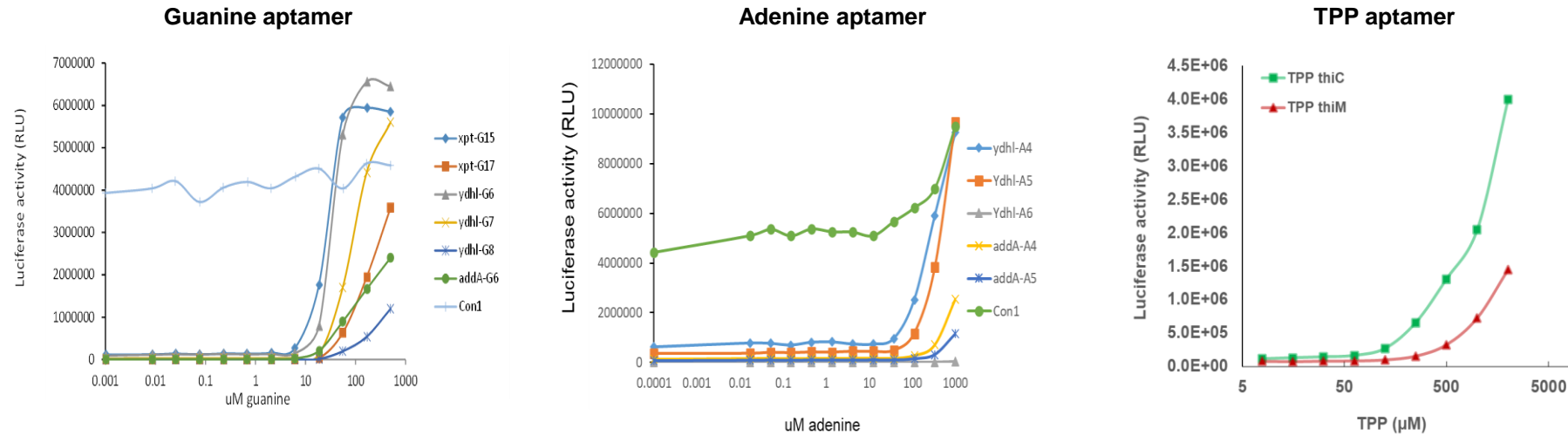

Unprecedented platform enables screening of small molecule-aptamer functional interaction within mammalian cells

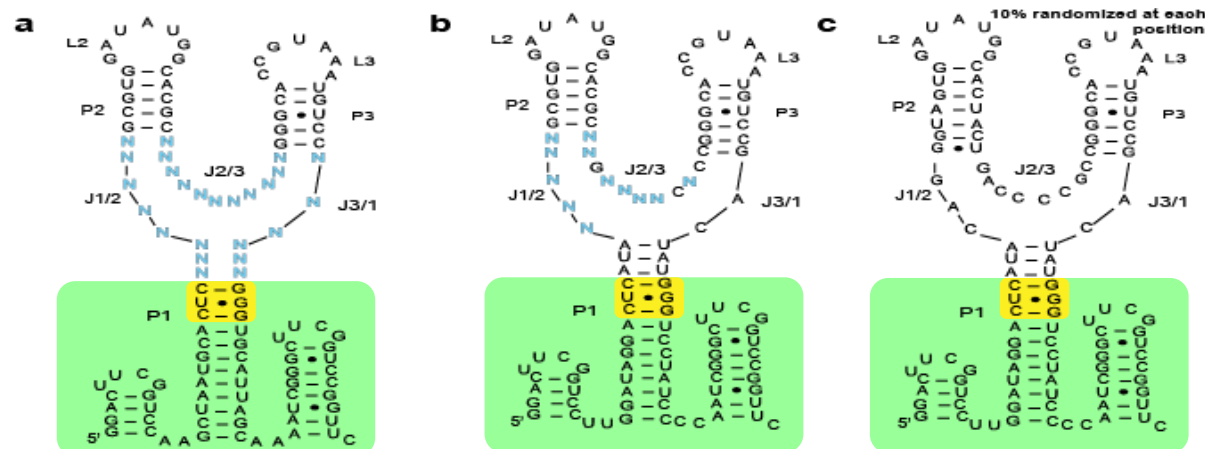

# High Dynamic Range Regulation Cassette Allows Screening for RNA Small Molecule Binding within Mammalian Cells

## Large aptamer libraries incorporated into the gene expression cassette

- Randomized aptamer sequence
- Selected natural aptamers
- Site directed mutagenesis of active aptamers

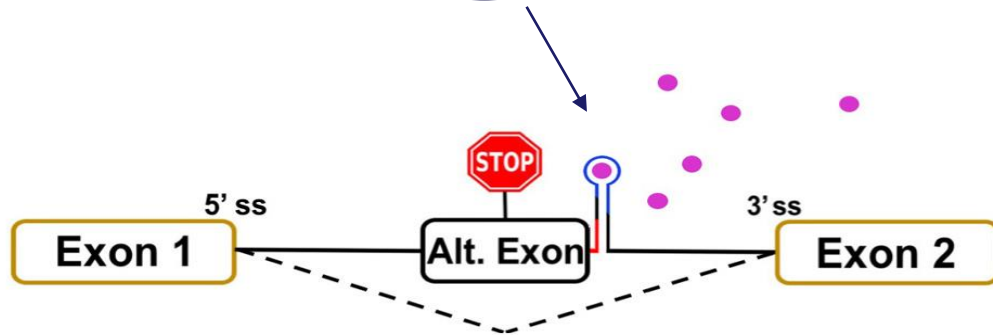
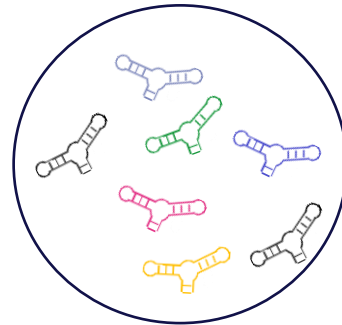

## Multiple small molecule libraries screened

- Known compound libraries
- Novel fragment-based libraries
- Active compounds modified to achieve different specific desired drug properties

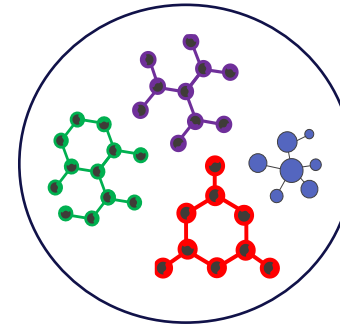

Compounds

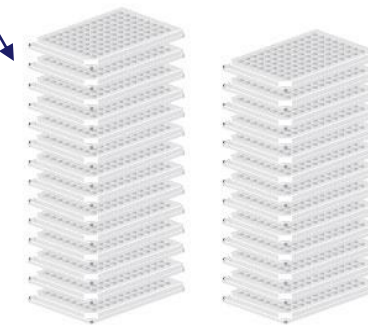

Mammalian cell culture

ONLY when small molecule binds to a new aptamer and drives hairpin formation and splicing regulation is the gene expressed



Assay readout: gene expression ON

The high dynamic range of the regulation cassette, for the first time, provides a system for screening small molecule aptamer binding within mammalian cells, with a read out that depends on functional small molecule aptamer association

# Robust Riboswitch Screening Platform

## Screen compound library against a riboswitch

Compound library

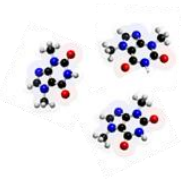

Cell-based screen

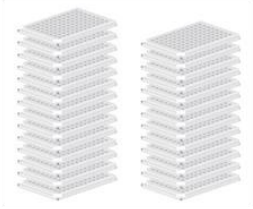

## Riboswitch inducers identified through screening

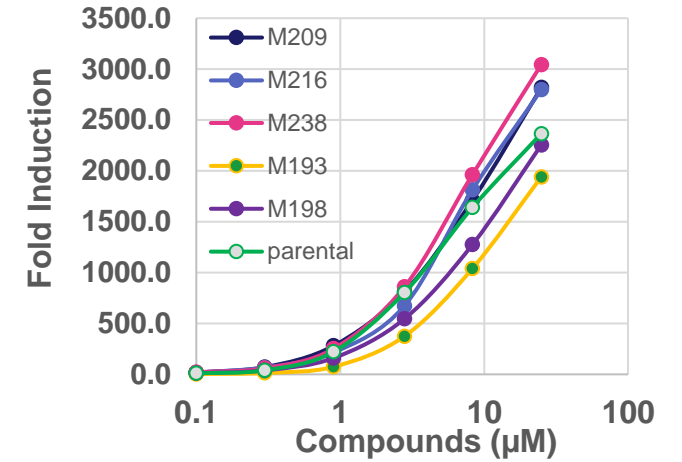
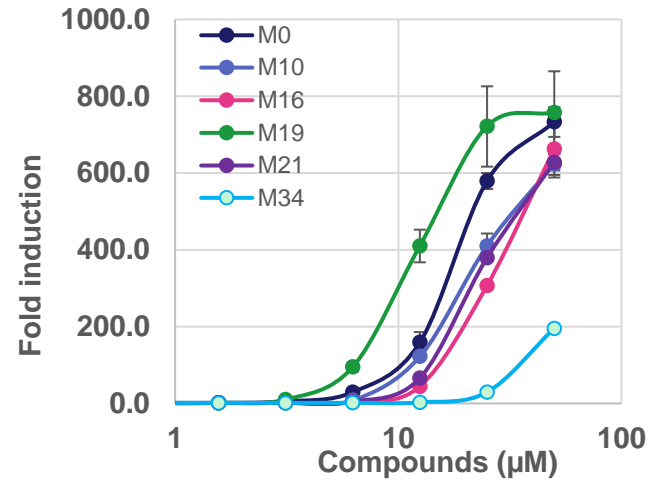

## Screen riboswitch library against a compound

Riboswitch library

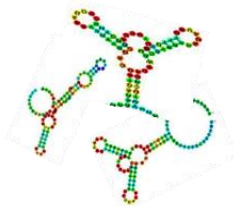

Cell-based screen

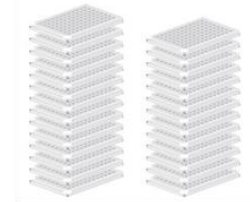

## Better riboswitches

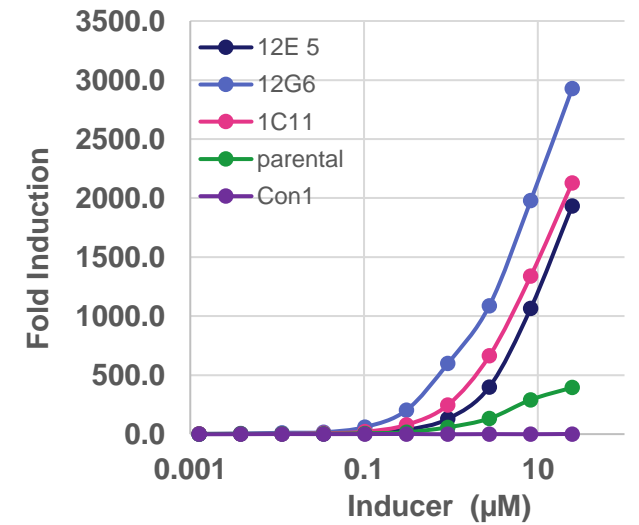
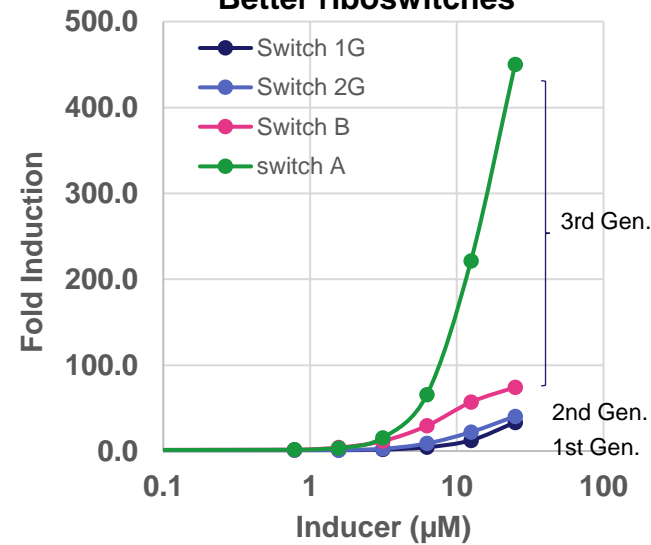



# Example: New Synthetic Compounds are Selected with Robust Activity on the Riboswitch

## Libraries of molecules are created targeting new compounds with desired properties

- Desired tissue distribution
- BBB penetrant
- Desired PK
- Increased stability
- Decreased stability

## Library A

Total 73 analogs generated:

57 compounds: > 50 fold

51 compounds: > 300 fold

38 compounds: > 1000 fold

15 compounds: > 2000 fold

Aptamers then iteratively evolved to each compound for increased potency and specificity

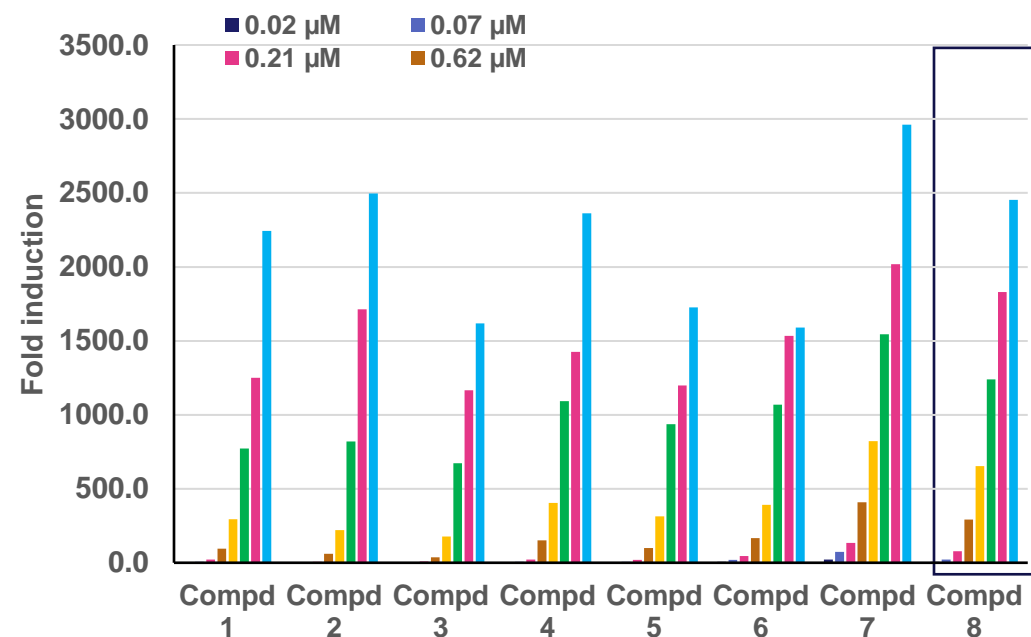

## Each compound:

- Fully characterize ADME and PK profile
- Evaluation of the physiochemistry properties
- *in-vitro* DDI
- Metabolic profiling
- Pharmacokinetic profile in mice, rats, dogs and NHPs
- Characterization of the PK/PD relationship
- Will be IND enabling
  
- **First novel compound to enter clinic in 2022, followed by pipeline of additional compounds currently in PK/Tox**



# *In Vivo* Precise Dose Responsive Regulation of Transgenes in Multiple Tissues



# Novel Riboswitch Regulates Transgene Expression *in vivo* in Precise Dose Response to Orally Delivered Inducer

## Precise control of transgene expression with single doses of orally delivered small molecule inducer

- Differential response to viral vector dose
- Dose response to small molecule inducer dose
- Dose response (and dynamic range difference) with different aptamer sequences

Liver

Tail vein injection

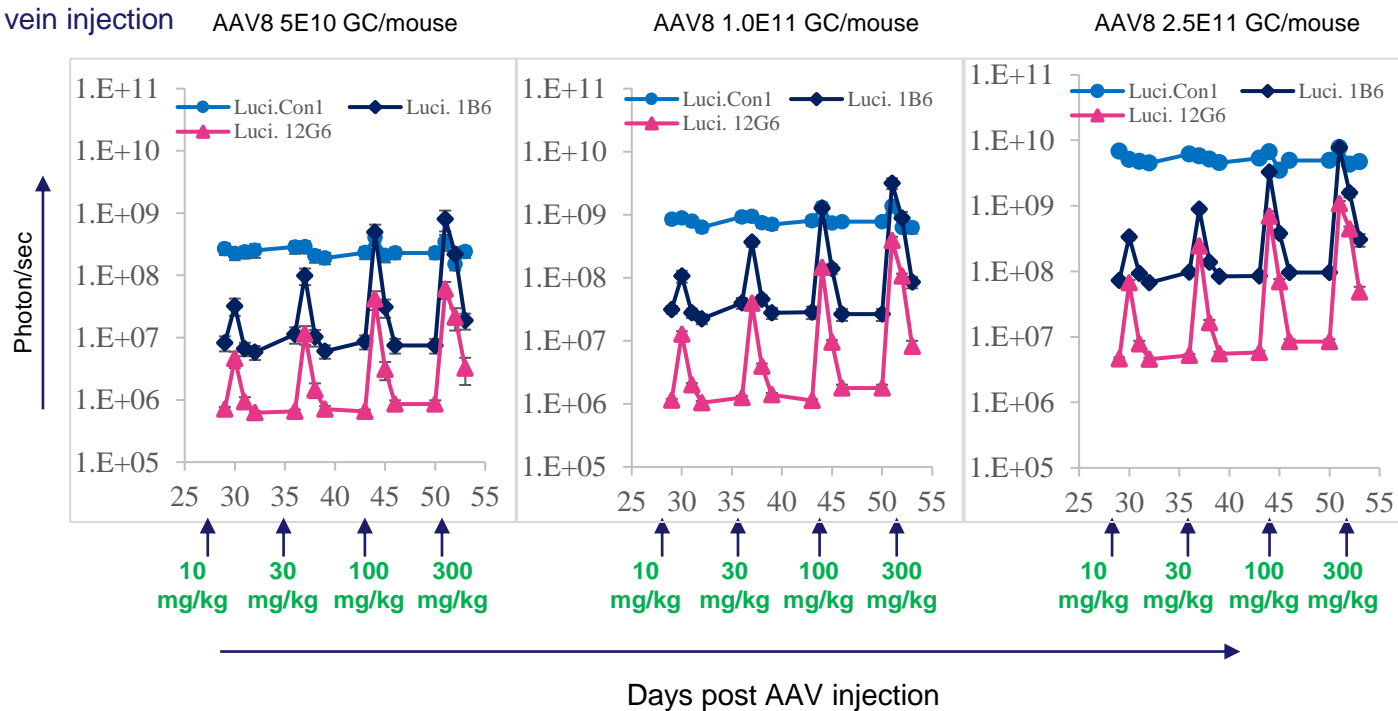

## Regulation of EPO *in vivo* Muscle – IM injection

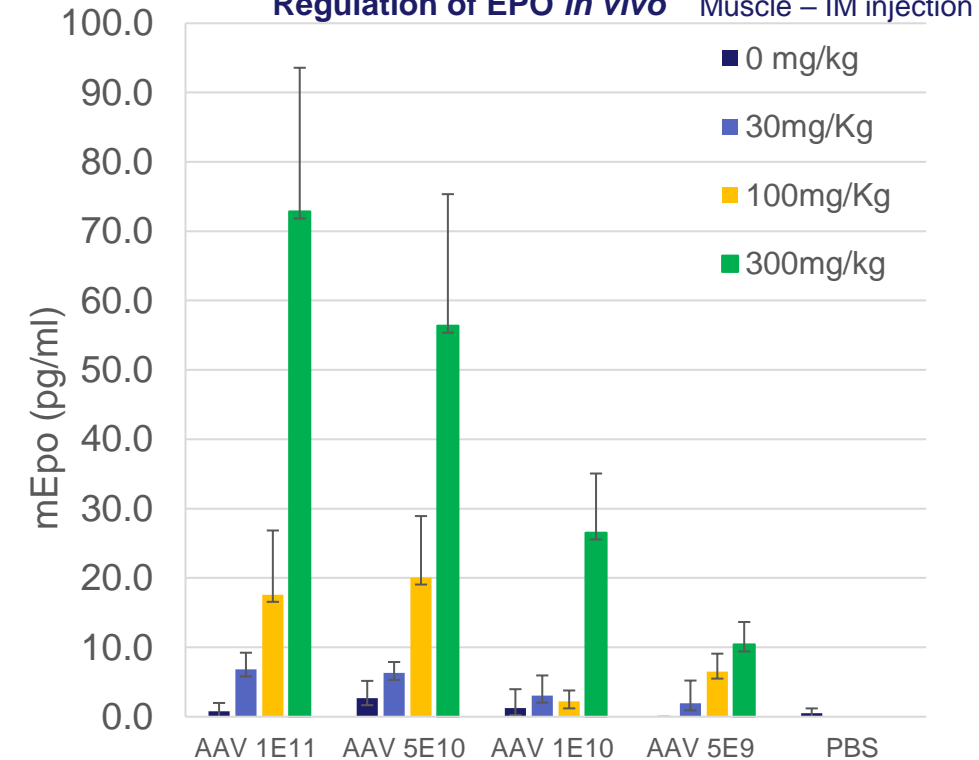



# Precise Regulation of Transgene Expression in the Liver in Response to Orally Delivered Inducer

## Transgene induction following a single inducer dosing 30 mg/kg PO

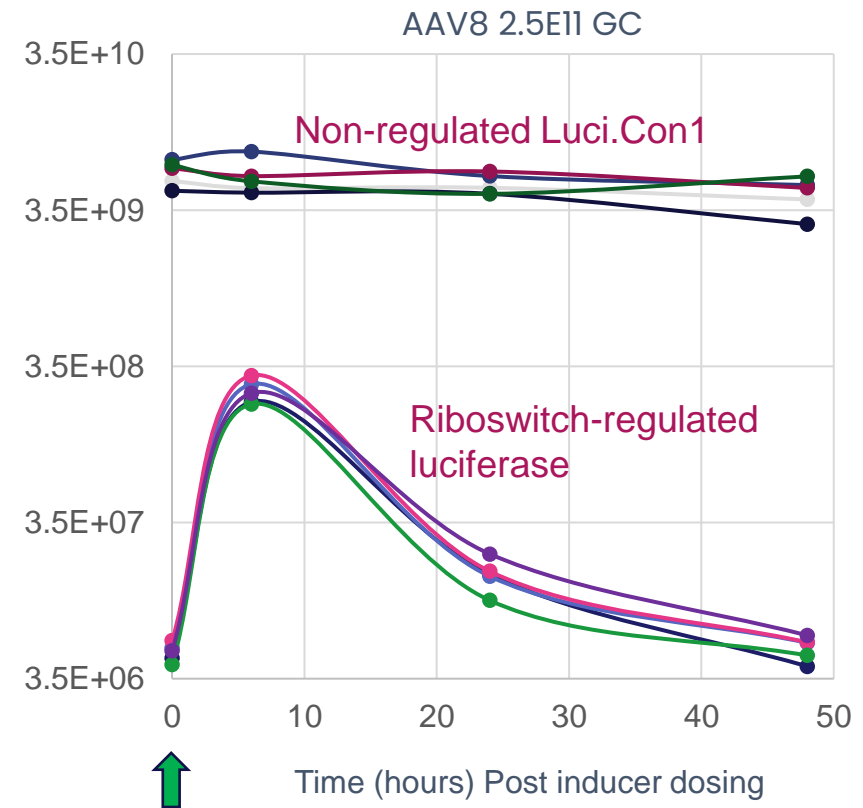
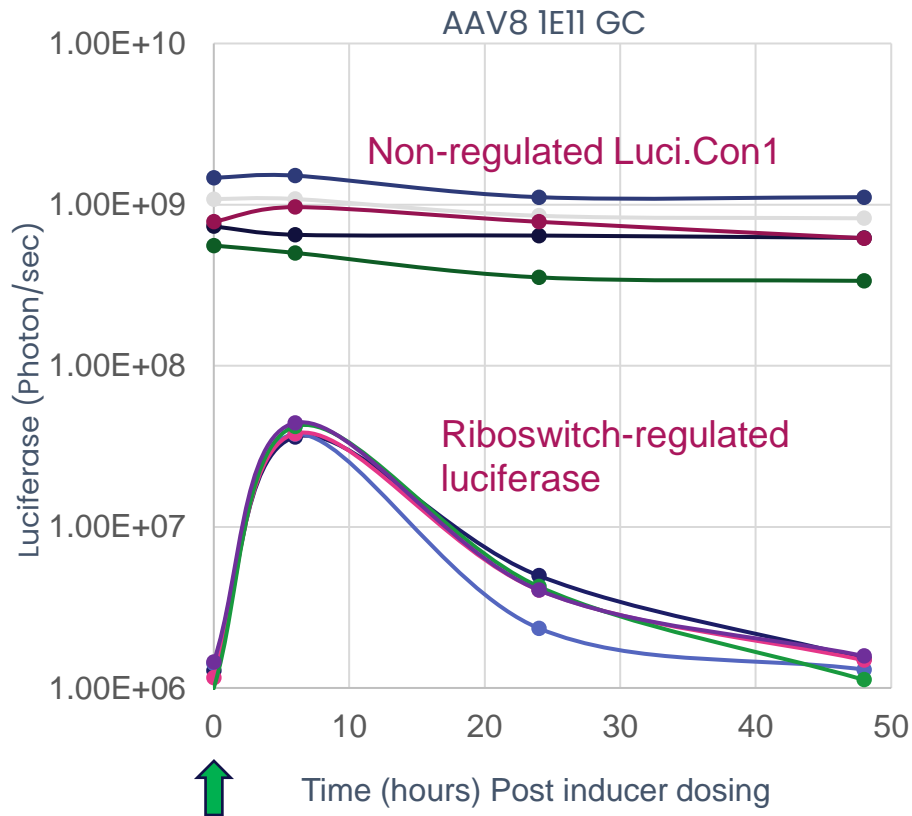

# Riboswitch Regulates AAV-mediated Transgene Expression in the Muscle with Precise Dose Response to Oral Small Molecule Inducer

Tissue concentration after P.O. dosing

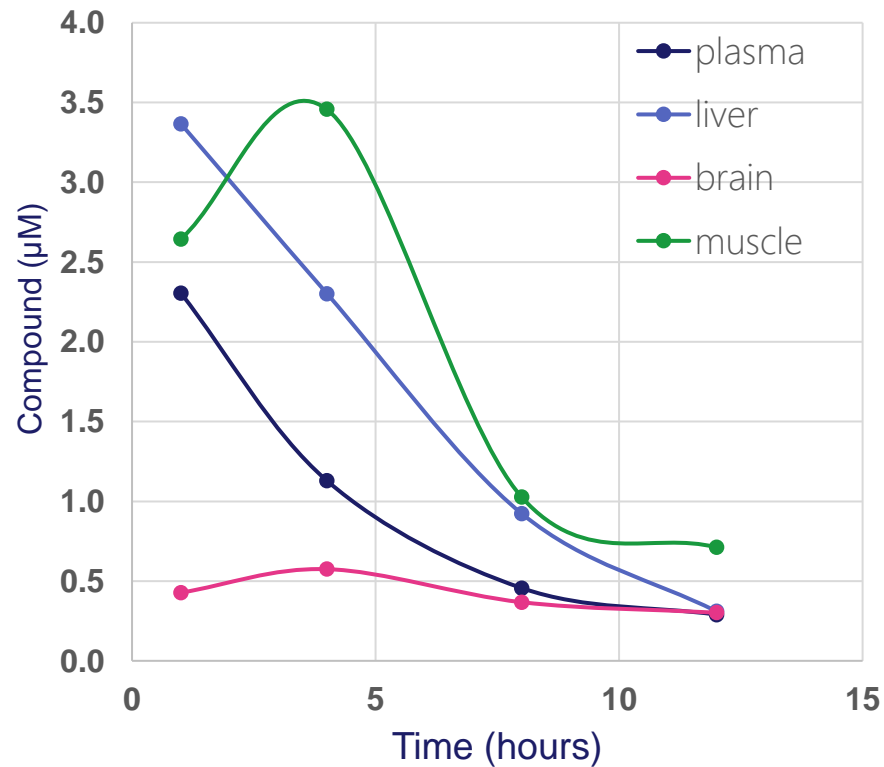

AAV I.M. injection  
Expression from muscle (left hindleg quadriceps)

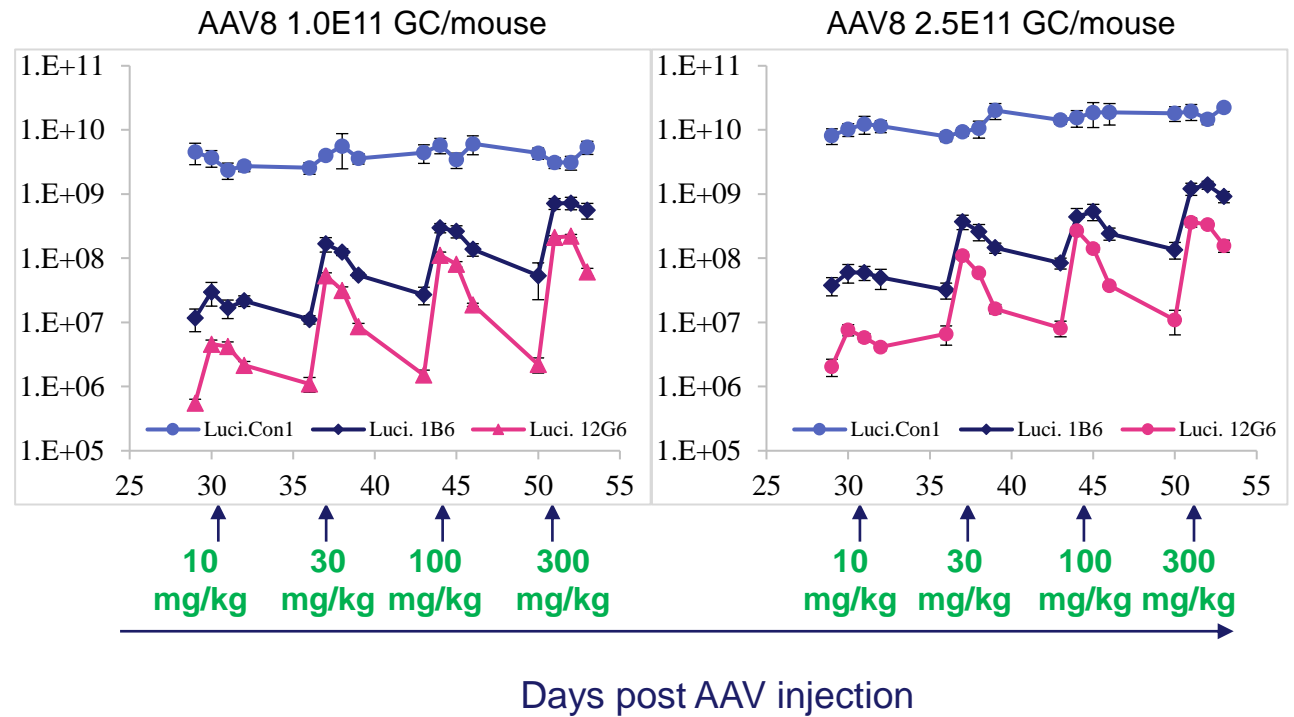



## Vectorized Biologics

We can not only vectorize and optimize viral vectors for expressing Antibodies and other therapeutic proteins – but we can precisely control their expression: rare disease gene replacement consistency of dosing or systemic Vectorized Antibodies  
Improved **Safety** and Consistency of dosing between patients



## Passive and Active Vaccines with built-in capacity for Oral Small Molecule Boosters

**Active Vaccine:** regulated vaccine mRNA can be boosted multiple times any time after first IM delivery as needed with an oral pill

**Passive Vaccine:** neutralizing antibodies activated systemically and durably as needed with an **oral pill** e.g., COVID-19, universal flu



## CNS expression of biologics – across the BBB

Potential to address one of the biggest challenges in medicine: getting large molecules across the blood-brain-barrier  
Gene Therapy delivered 1x within the BBB and activated using a small molecule that crosses the BBB



## Short-lived Therapeutic Hormones and Peptides

Precise activation of naturally short-lived peptides and hormones using an oral pill; and allows for combinations of multiple natural peptides regulated together.



## Ocular expression of therapeutic proteins

Tight control of expression of therapeutic proteins in the eye with eye drop formulation of small-molecule inducer; improved safety and new targets



## Gene Editing

Tight regulation of nucleases targeting DNA or RNA e.g., Cas9 and CasRx



## Cell Therapy

Controlled expression of CAR, 'Kill switches'; both 'on' and 'off' switches



## Pricing of Gene Therapies

Pay for the pill which delivers the active therapeutic protein, not just the 1x delivery of the gene therapy

## Therapeutic Antibodies:

- Anti-PCSK9
- Anti-VEGFR2 (ophthalmology)
- Anti-Amyloid
- Anti-IL-17
- Anti-PD1
- Anti-HER2



## Therapeutic Hormones/Cytokines/Peptides:

- Epo
- hGH
- PTH
- Insulin
- GLP-1R agonists
- Gut peptide combinations:  
GLP1- GIP;  
GLP1 GIP PYY Glucagon etc.



## Therapeutic Nucleases (Targeting RNAs):

- Cas9
- CasRx





## Therapeutic Antibodies:

- Anti-PCSK9
- Anti-VEGFR2 (ophthalmology)
- Anti-Amyloid
- Anti-IL-17
- Anti-PD1
- Anti-HER2



## Therapeutic Hormones/Cytokines/Peptides:

- Epo
- hGH
- PTH
- Insulin
- GLP-1R agonists
- Gut peptide combinations:  
GLP1- GIP;  
GLP1 GIP PYY Glucagon etc.



## Therapeutic Nucleases (Targeting RNAs):

- Cas9
- CasRx



# Riboswitch Tightly Regulates Expression of Therapeutic Antibodies

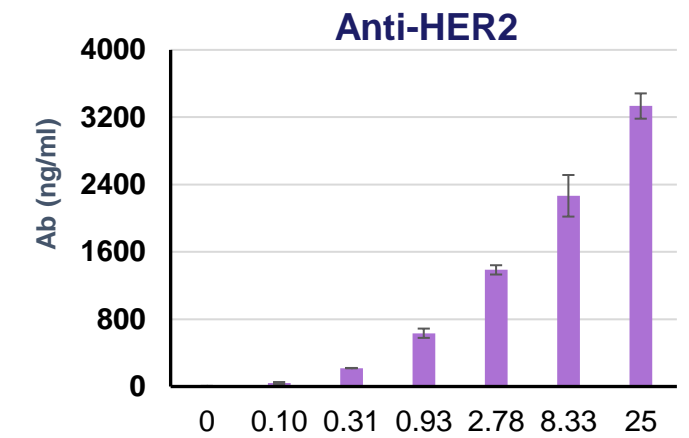
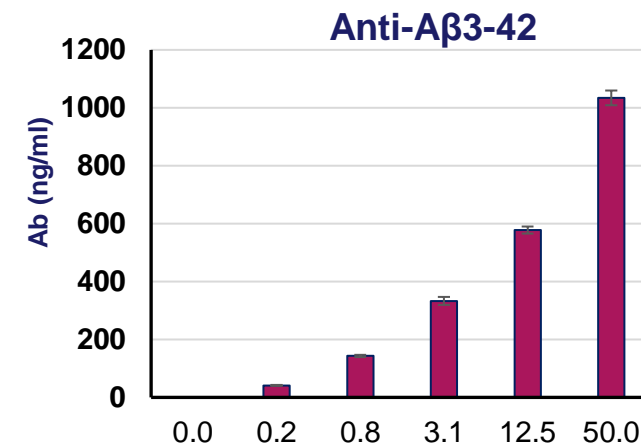
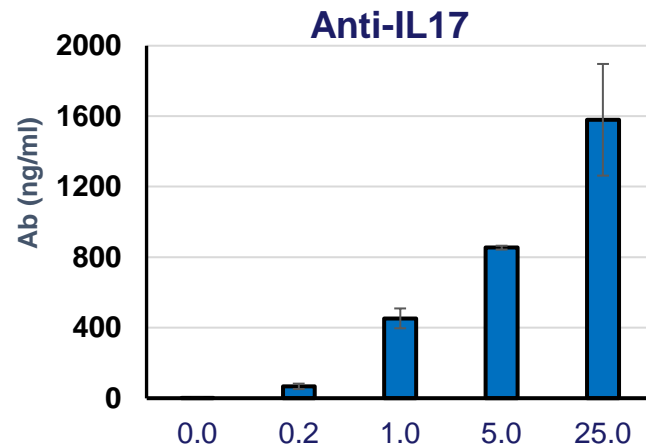
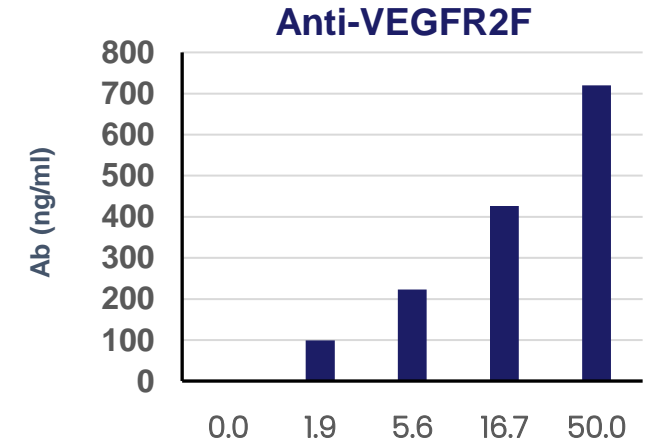
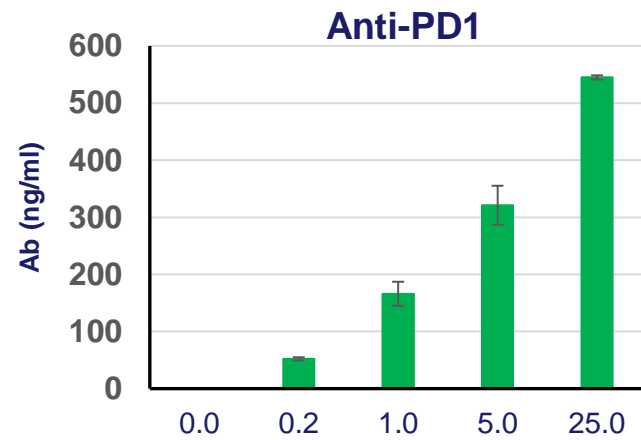
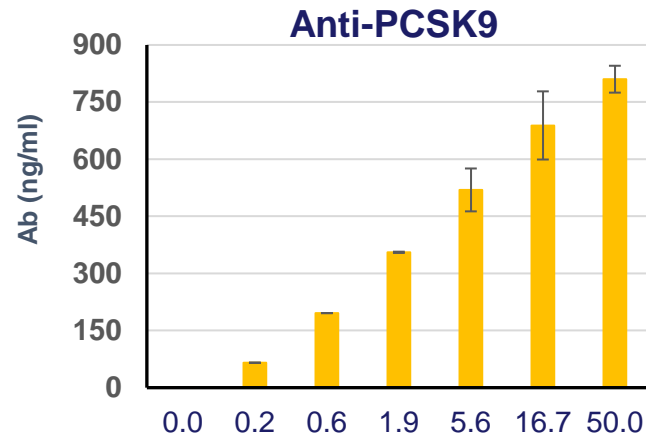
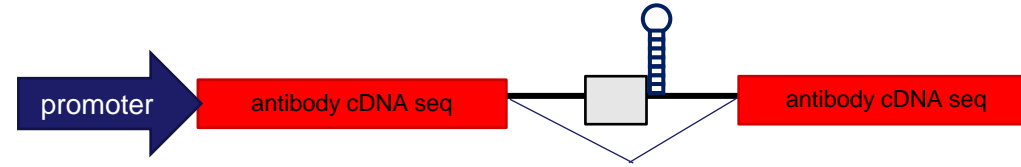

Small molecule inducer (μM)

# Riboswitch Tightly Regulates Anti-PCSK9 Antibody Expression in Mice in Response to Orally Administered Inducer

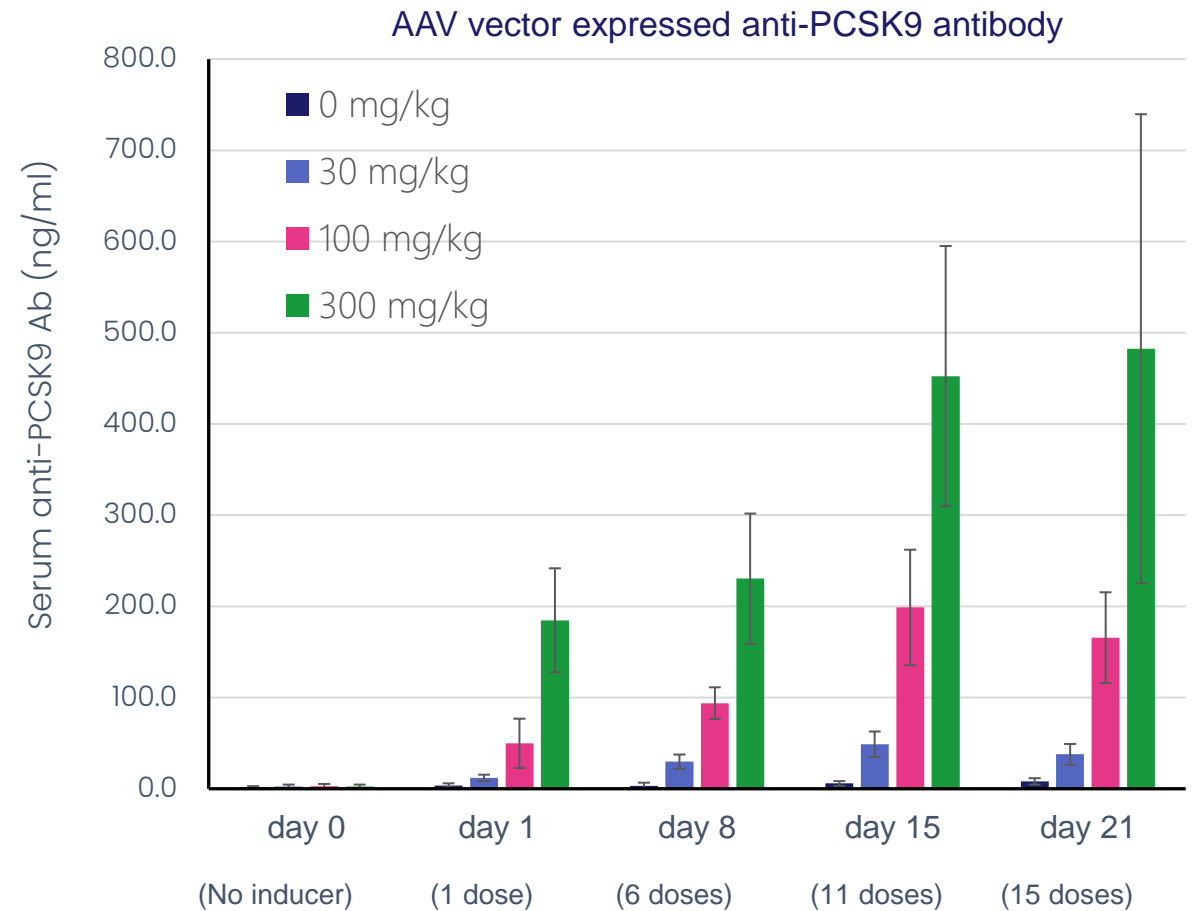
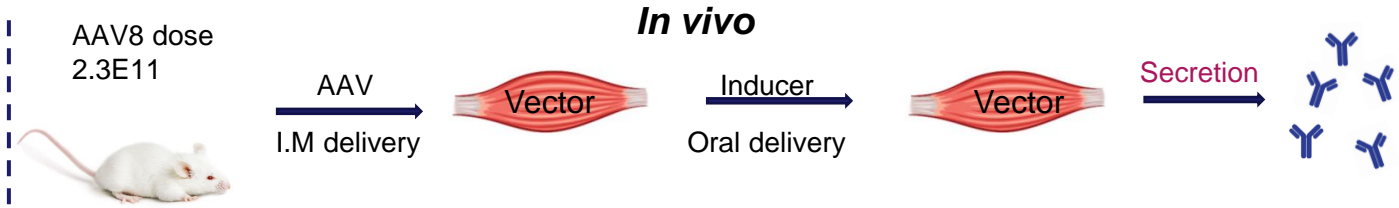
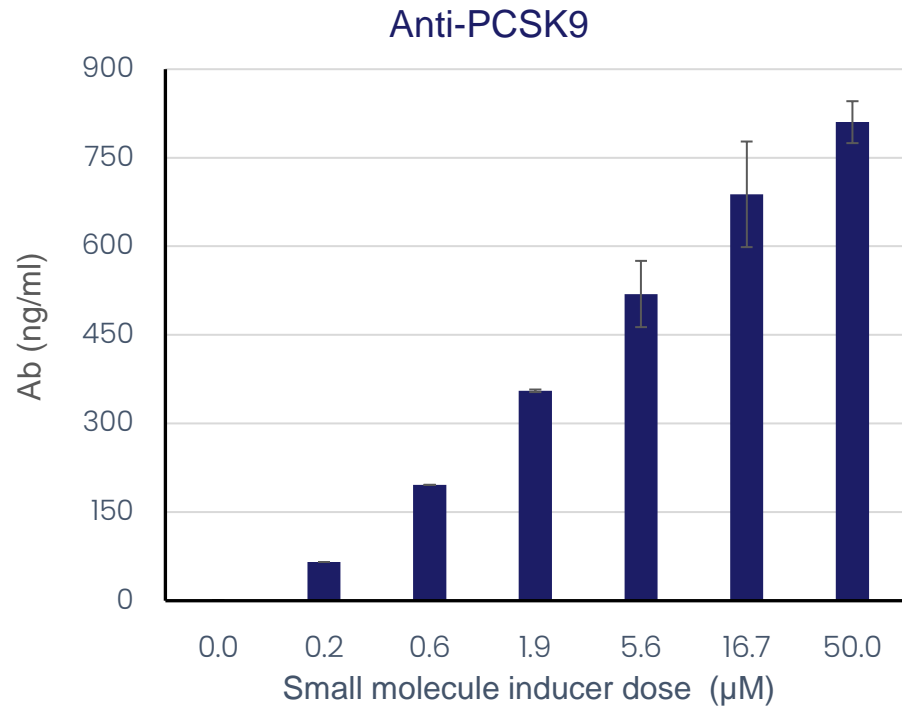
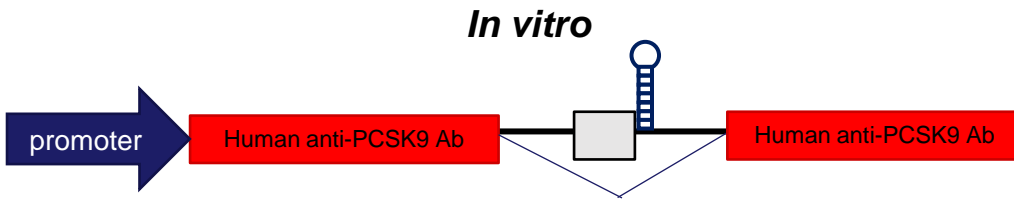

# Riboswitch Regulated Anti-PD1 Antibody Expression in Mice in Response to Orally Administered Inducer

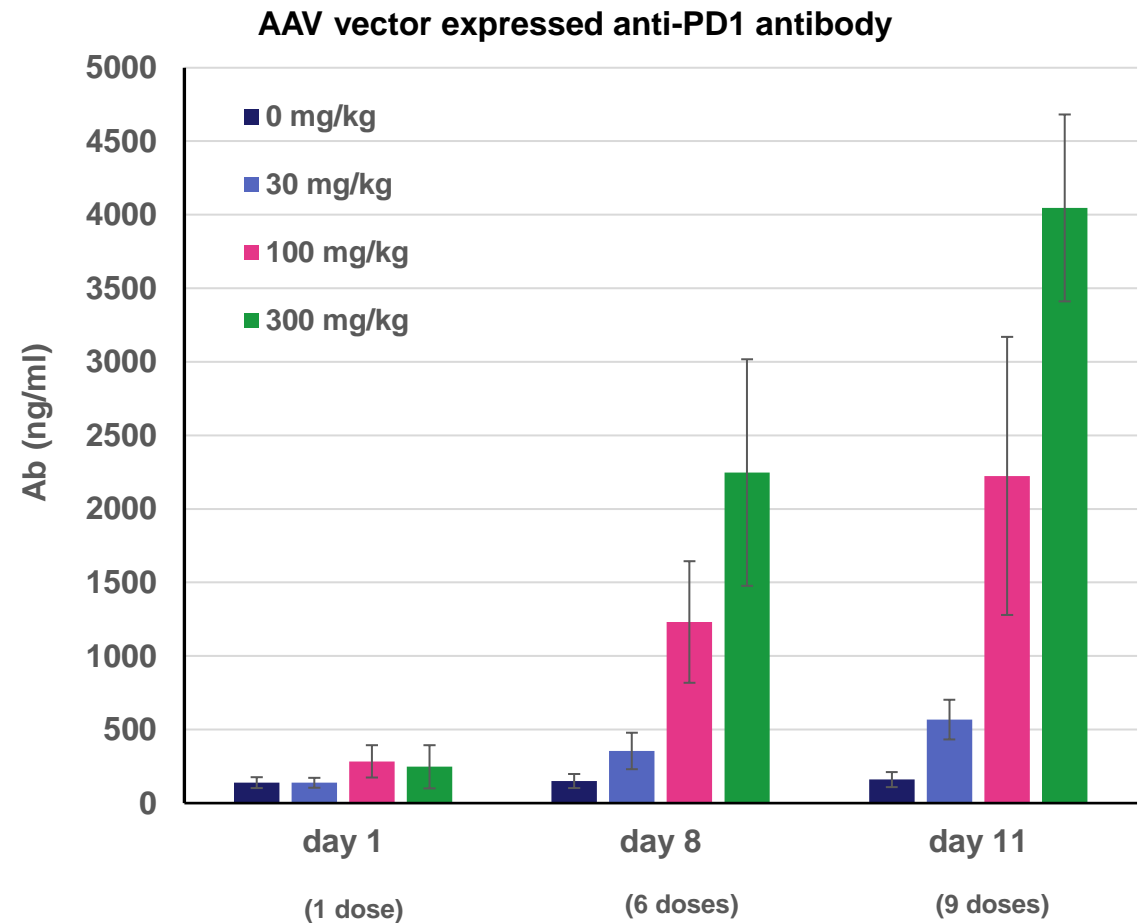
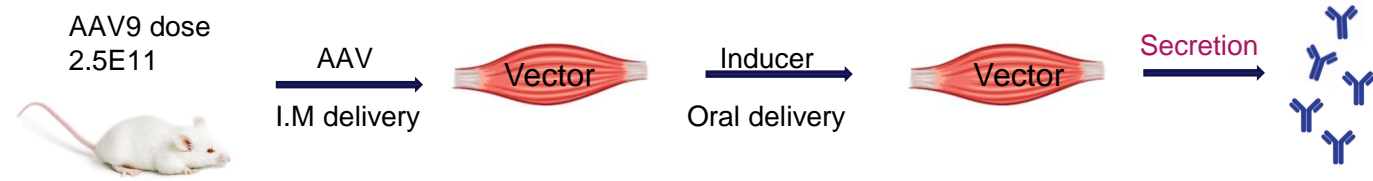
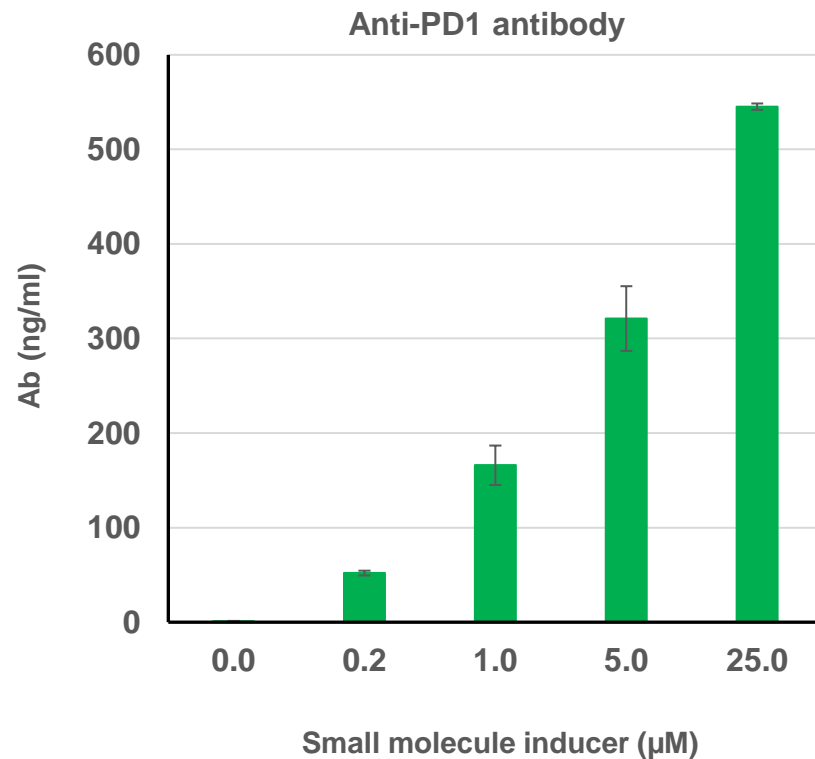
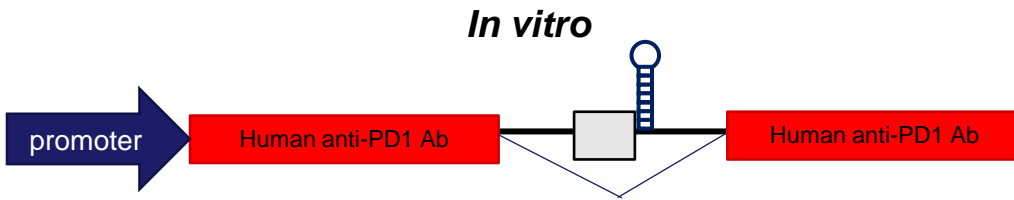



## Therapeutic Antibodies:

- Anti-PCSK9
- Anti-VEGFR2 (ophthalmology)
- Anti-Amyloid
- Anti-IL-17
- Anti-PD1
- Anti-HER2



## Therapeutic Hormones/Cytokines/Peptides:

- Epo
- hGH
- PTH
- Insulin
- GLP-1R agonists
- Gut peptide combinations:  
GLP1- GIP;  
GLP1 GIP PYY Glucagon etc.



## Therapeutic Nucleases (Targeting RNAs):

- Cas9
- CasRx



# Riboswitch Regulated CRISPR-CasRx Activity

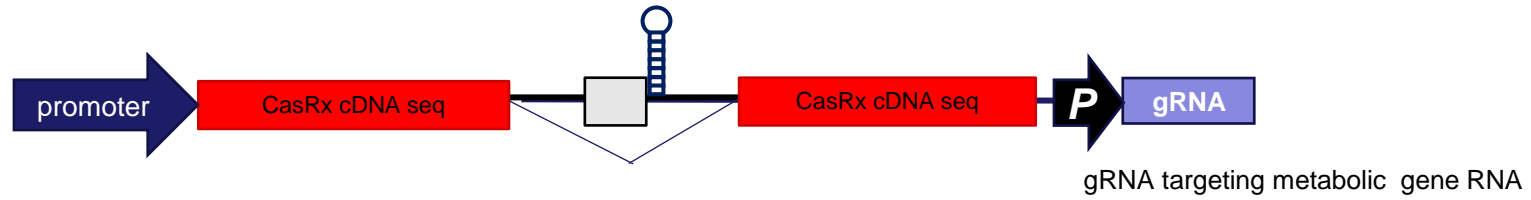

Knock down efficiency

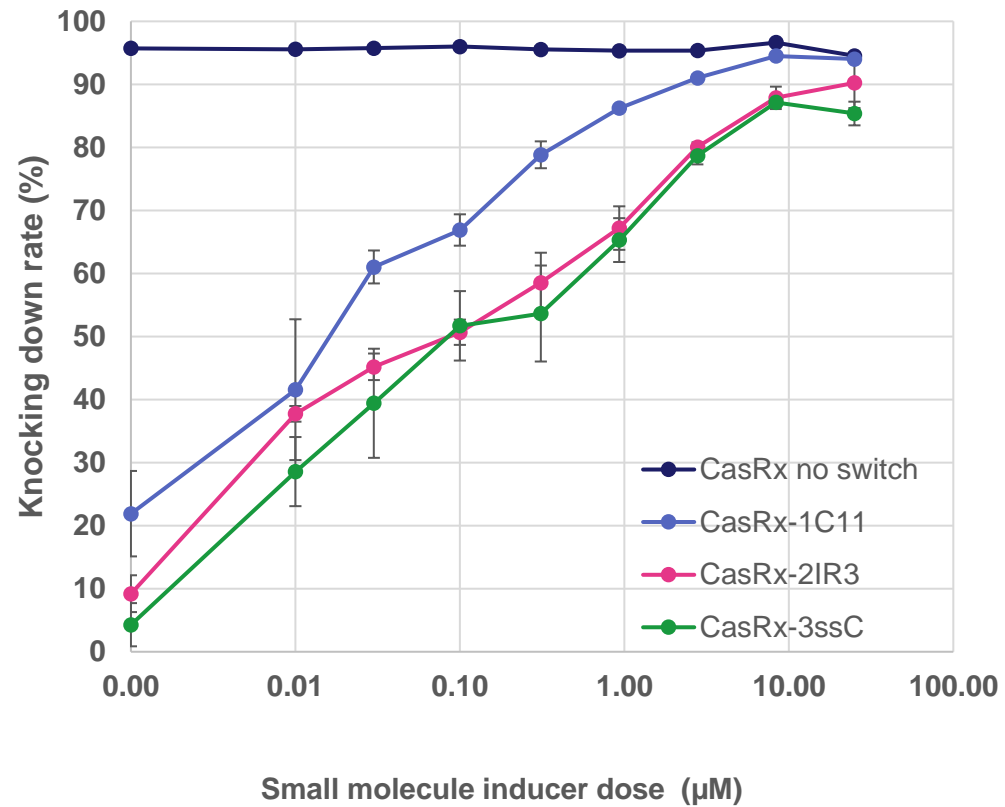

# Tight vs Loose Switch in Regulating Antibody Expression

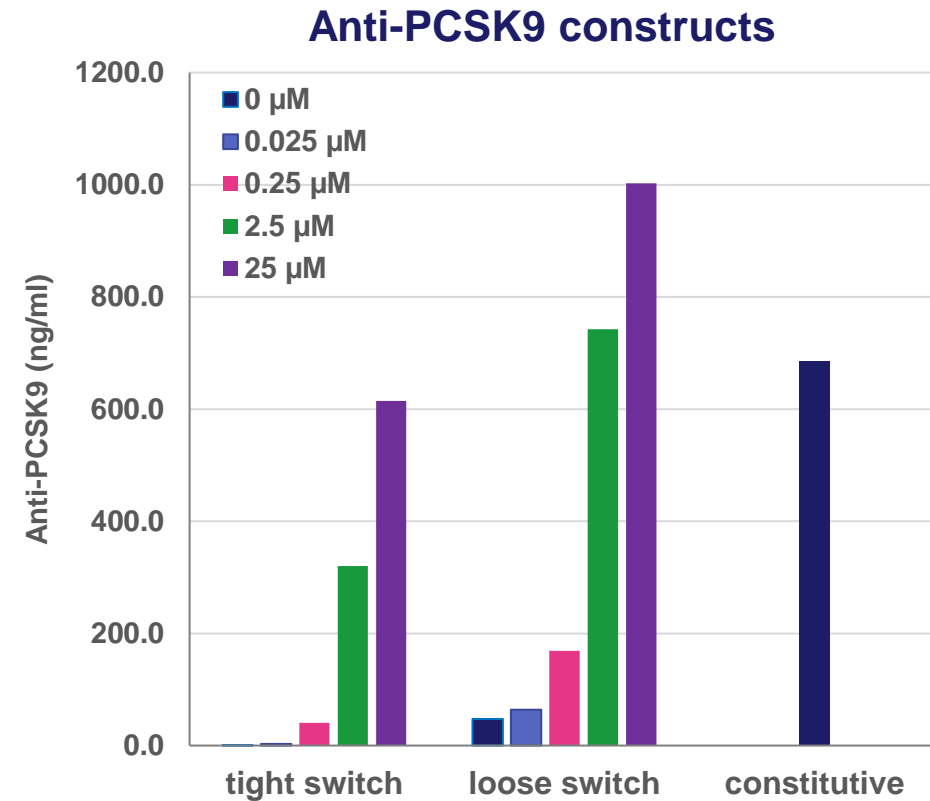
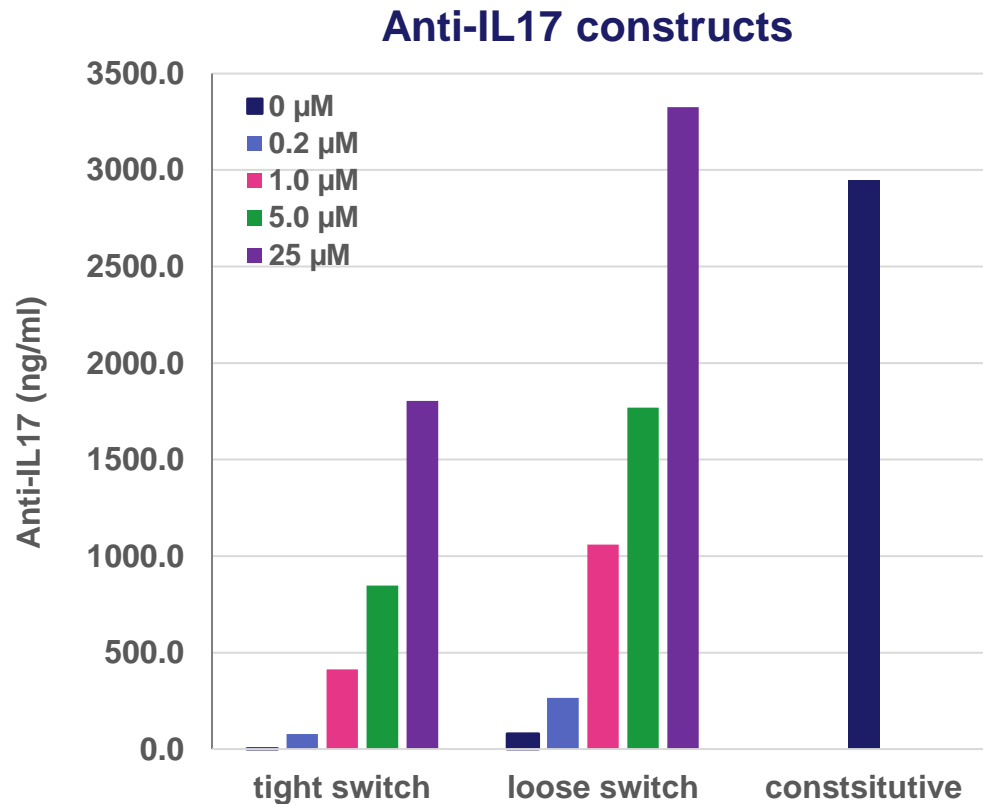

# Therapeutic Genes Vectorized, Optimized and Regulated by Riboswitch Technology

## Therapeutic Antibodies:

- Anti-PCSK9
- Anti-VEGFR2 (ophthalmology)
- Anti-Amyloid
- Anti-IL-17
- Anti-PD1
- Anti-HER2



## Therapeutic Hormones/Cytokines/Peptides:

- Epo
- hGH
- PTH
- Insulin
- GLP-1R agonists
- Gut peptide combinations:  
GLP1- GIP;  
GLP1 GIP PYY Glucagon etc.



## Therapeutic Nucleases (Targeting RNAs):

- Cas9
- CasRx





# Tight Dose Response Control of Expression of Peptides and Hormones

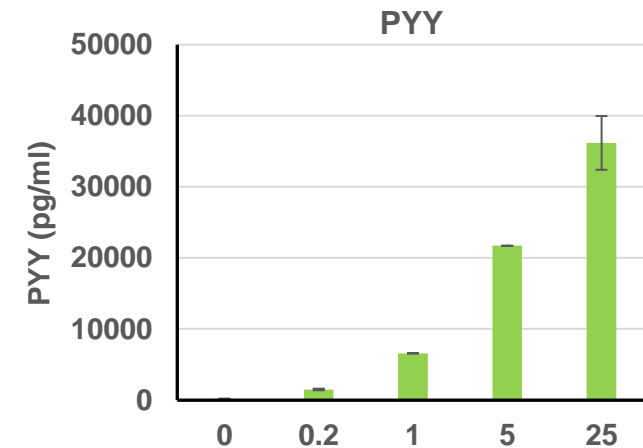
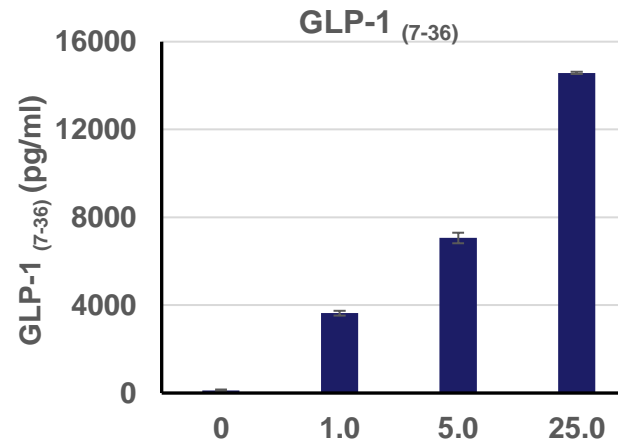
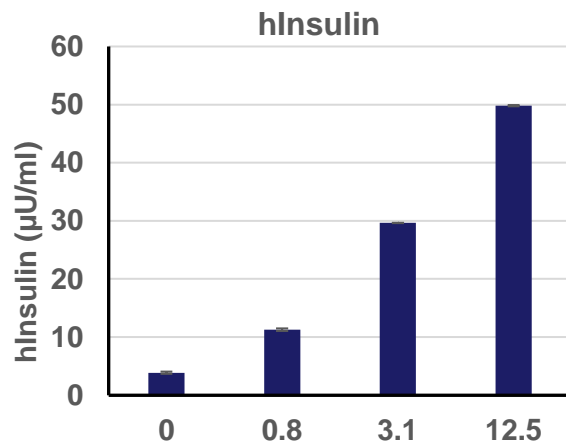
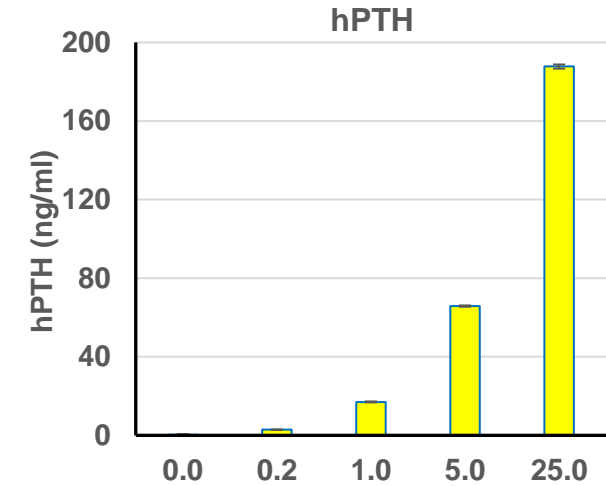
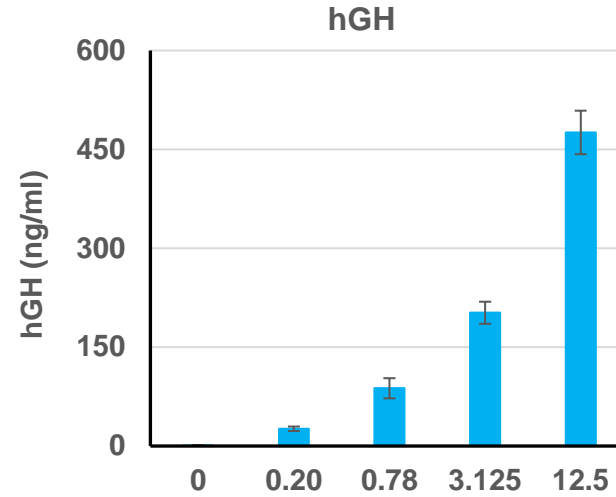
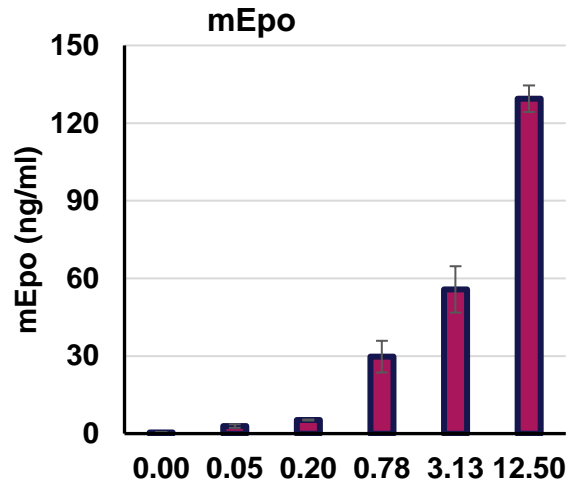

Small molecule inducer (μM)

# Tight Dose Response Regulation of Expression of Erythropoietin (Epo) in Mammalian Cells and *in vivo*

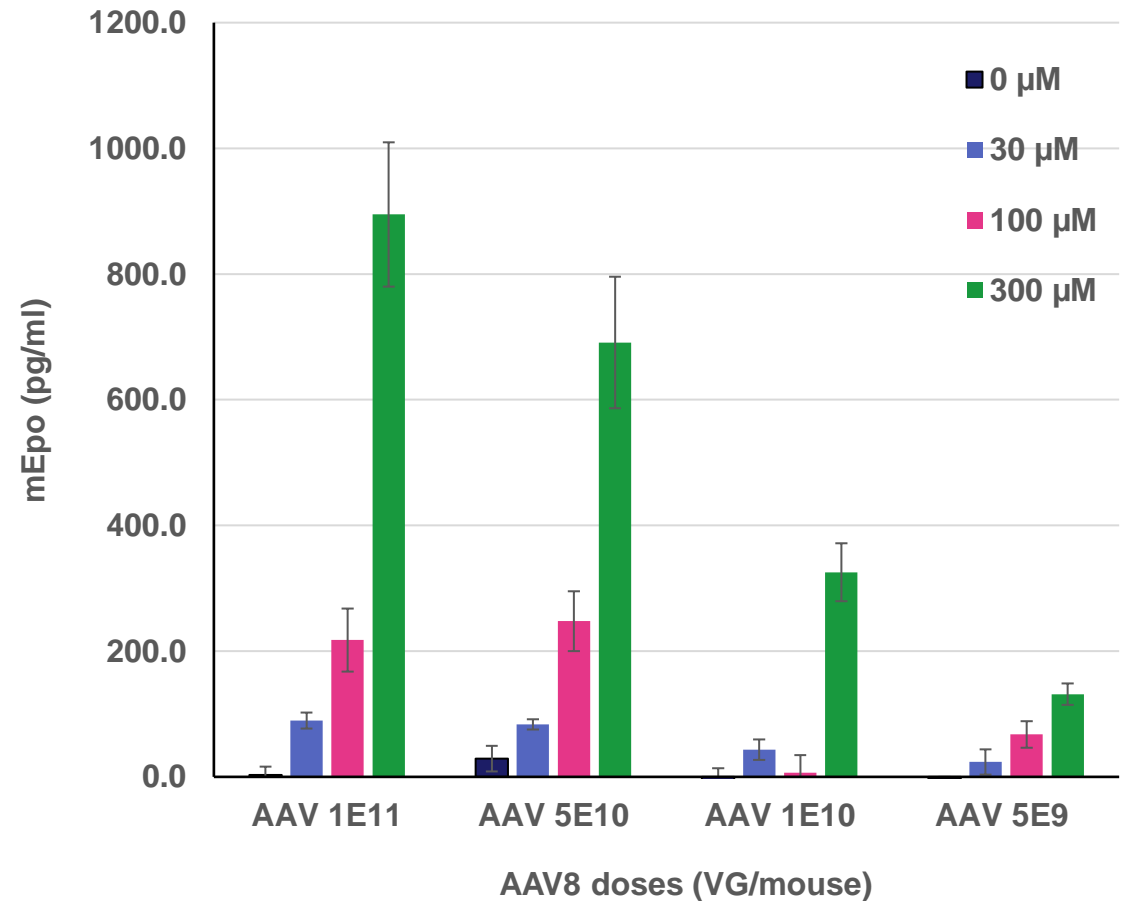
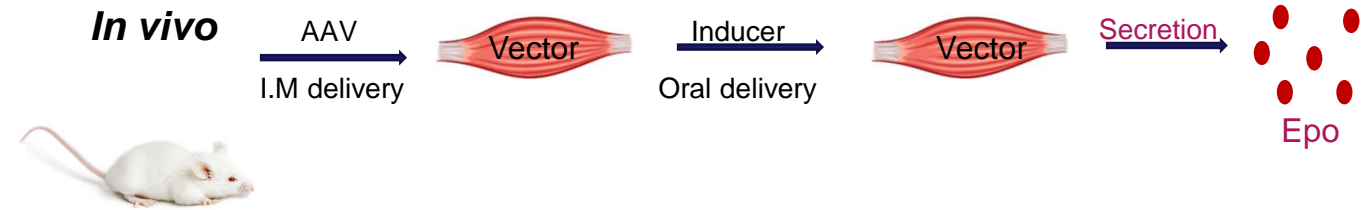
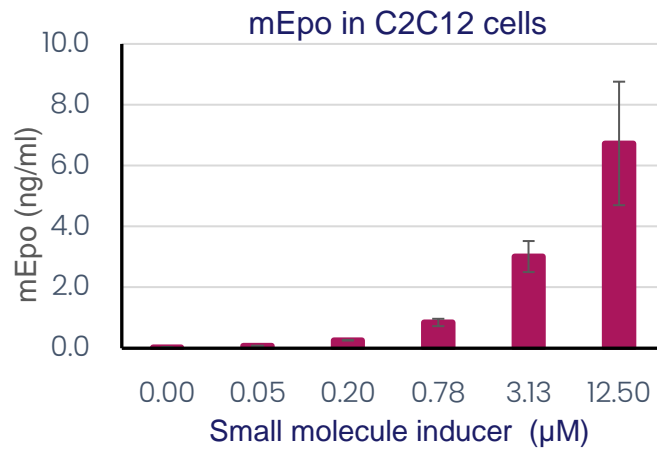
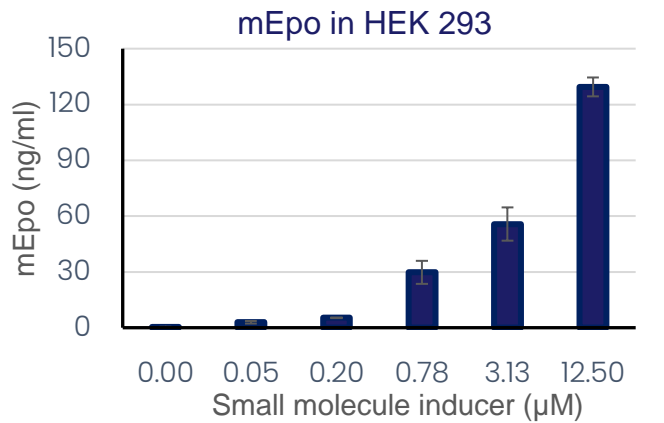
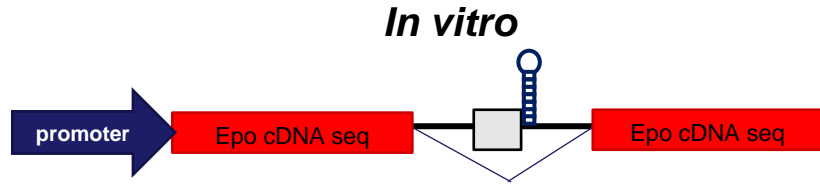

# Tight Regulation of Epo *in vivo* via Orally Dosed Small Molecule

Tight 12G6 switch  
AAV8 I.M.  $5 \times 10^9$  vg/mouse



AAV  
I.M delivery



Inducer  
Oral delivery



Secretion



Epo

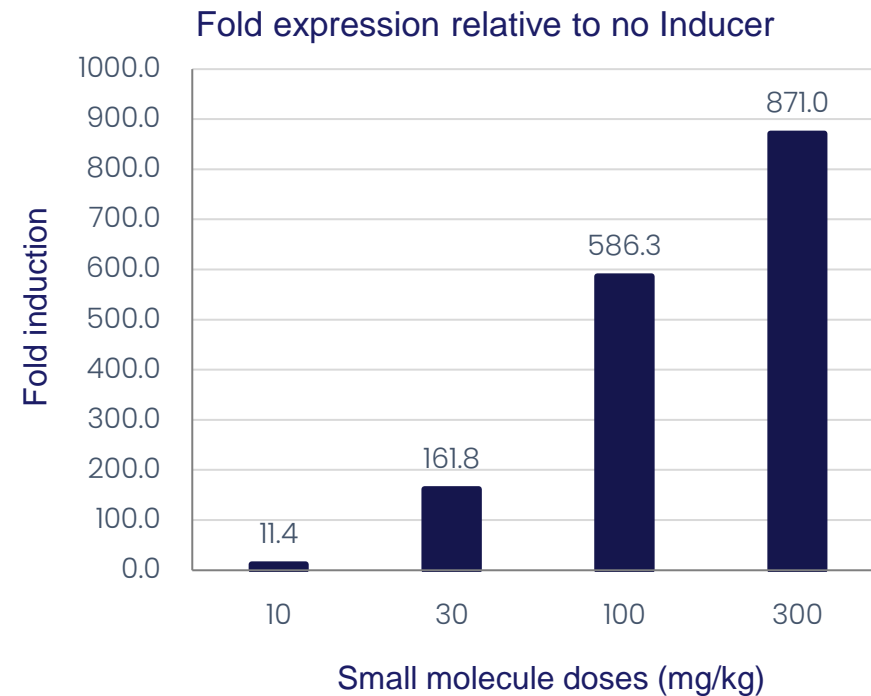
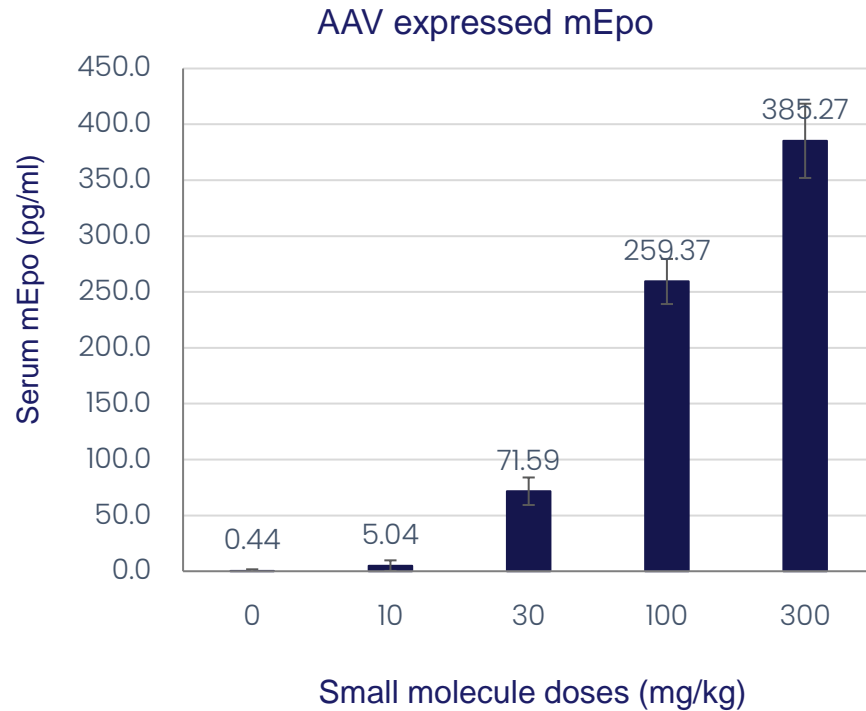

# Riboswitch Controlled Secretion of Erythropoietin Restores Hematocrit in Chronic Kidney Disease (CKD) Associated Anemia in a Dose Response to Oral Small Molecule

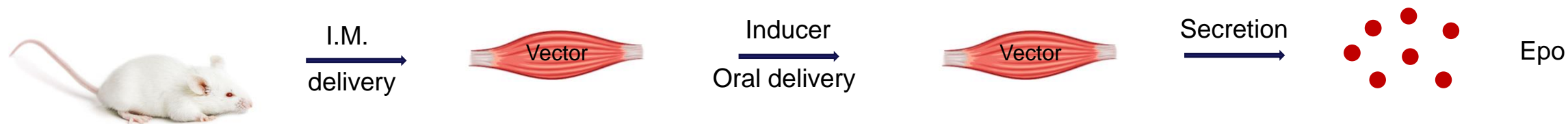

### Low dose inducer

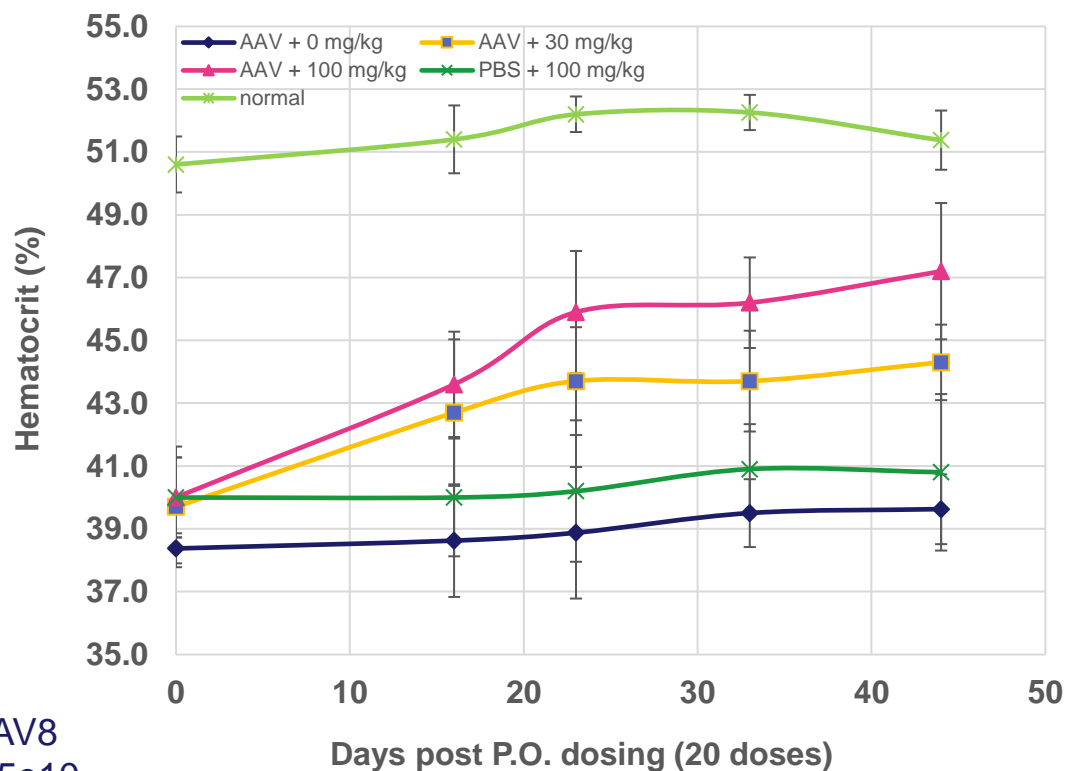

AAV8  
2.5e10

### High dose inducer

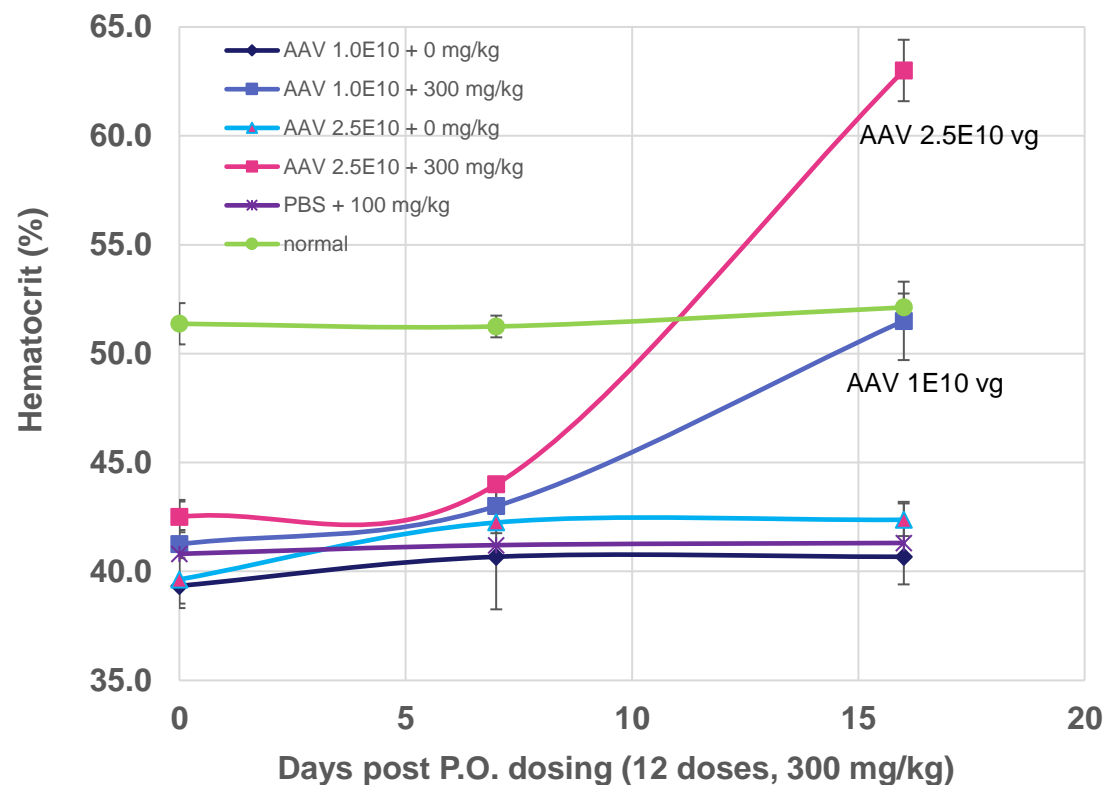



# Controlled Secretion of Parathyroid Hormone (PTH) Increased Serum Calcium

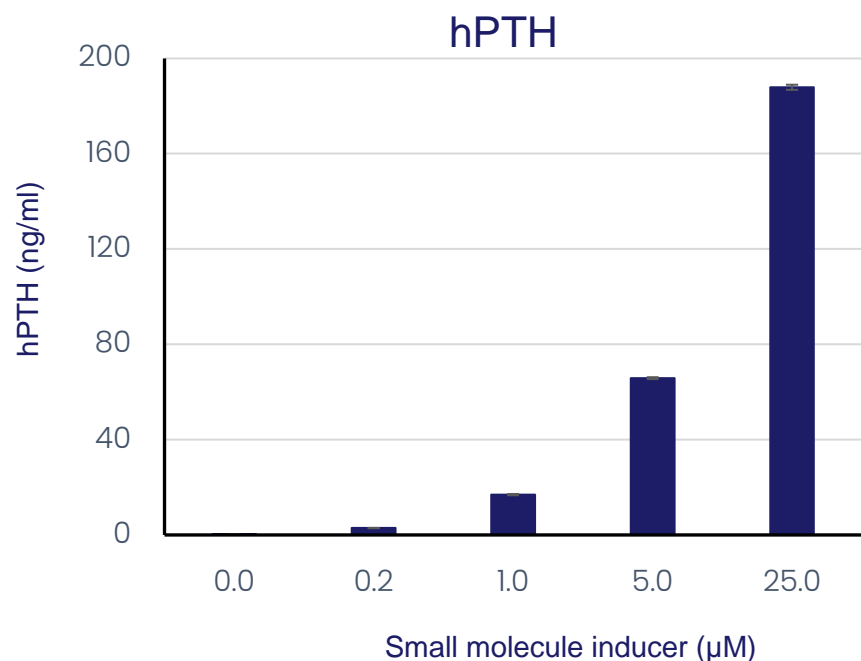
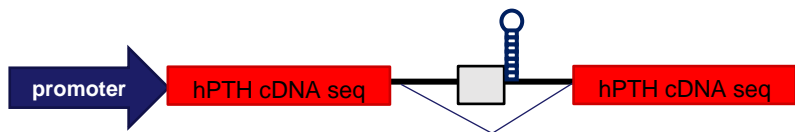

Oral daily dosing of inducer

AAV 2.5E11  
vg/mouse



Vector expressed hPTH

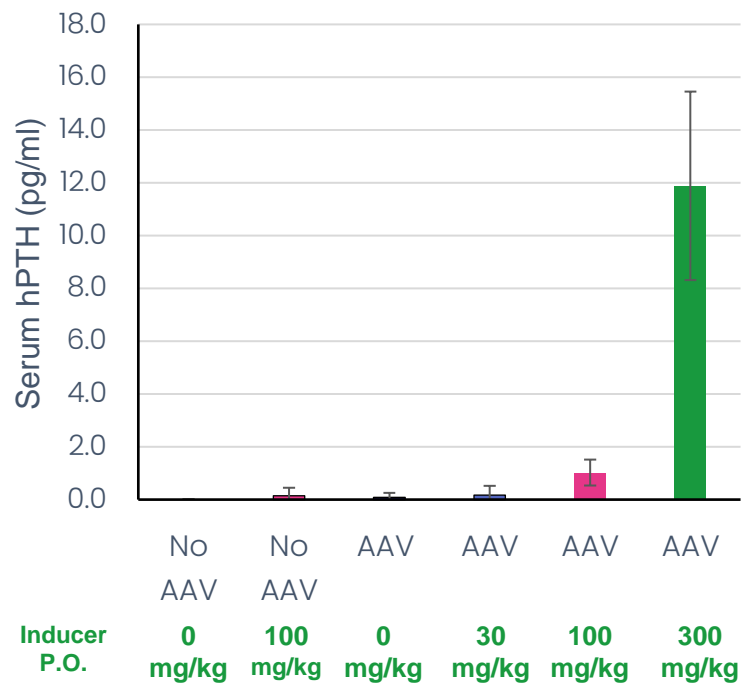

Inducer  
Oral delivery



Secretion

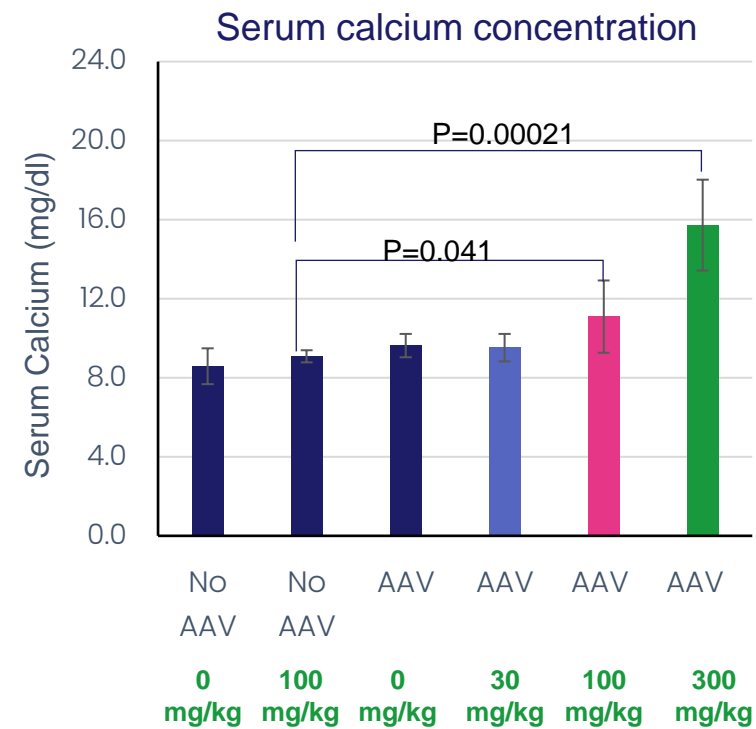

Post 3 oral doses

# Tight Regulation of High Expressing Insulin Vector

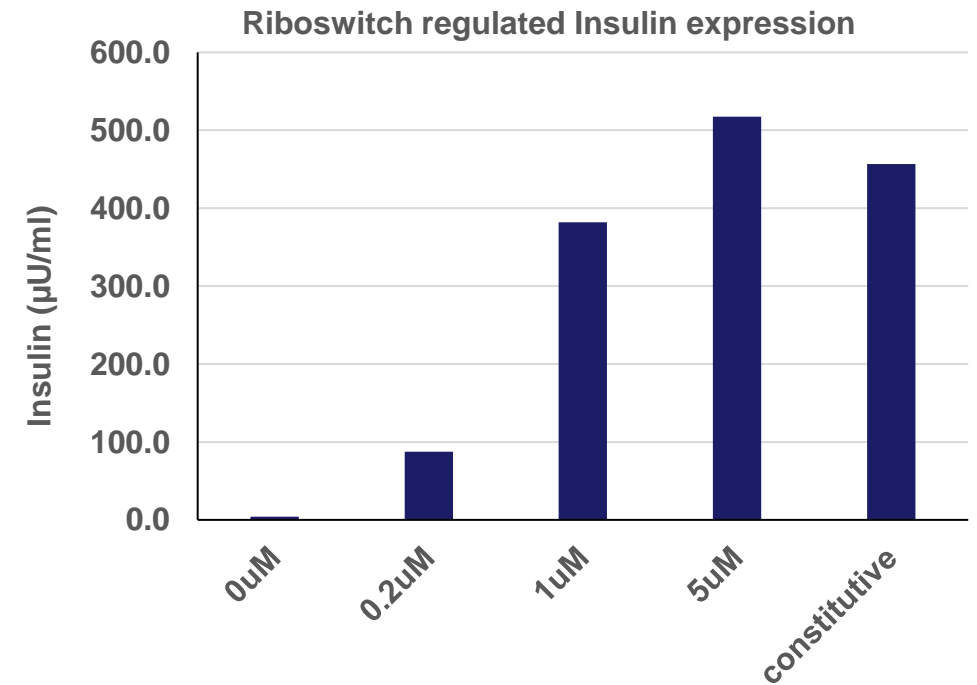
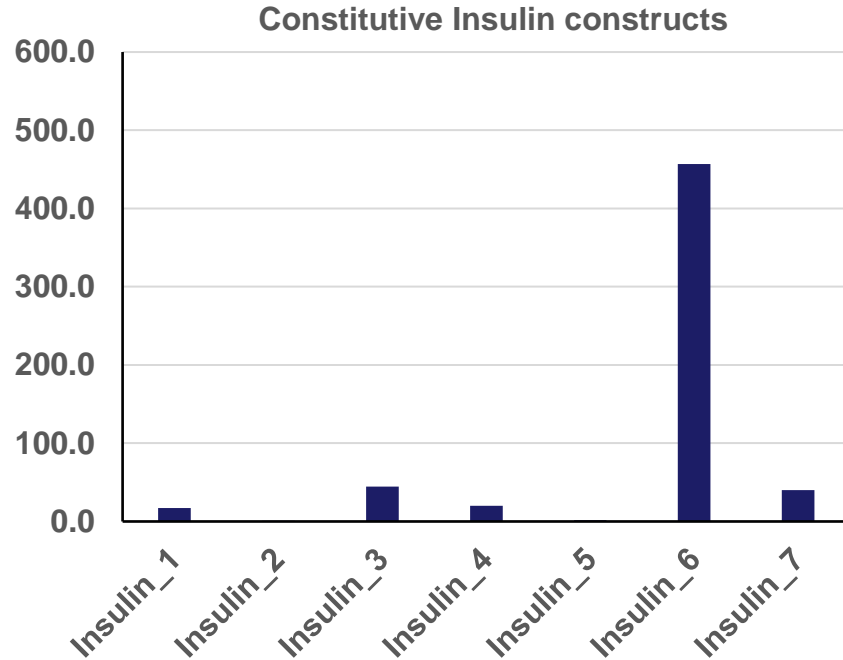
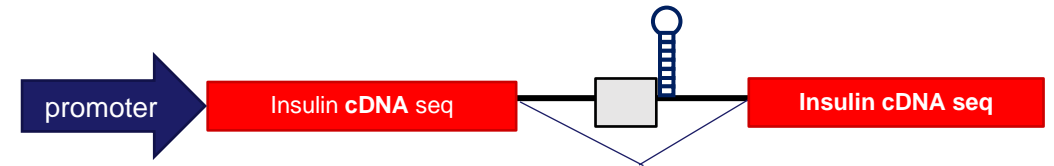

## Single Peptide Constructs

GLP-1

GIP

Glucagon

Oxyntomodulin

PYY

Amylin

## Combination Peptide Constructs

GLP-1

GLP-1

GLP-1

GIP

GLP-1

GLP-1

GLP-1

GLP-1

Glucagon

GIP

GLP-1

Oxyntomodulin

PYY

GLP-1

Amylin

PYY

GLP-1

GIP

PYY

# Gut Peptide GLP-1 is Tightly Regulated in Mammalian Cells

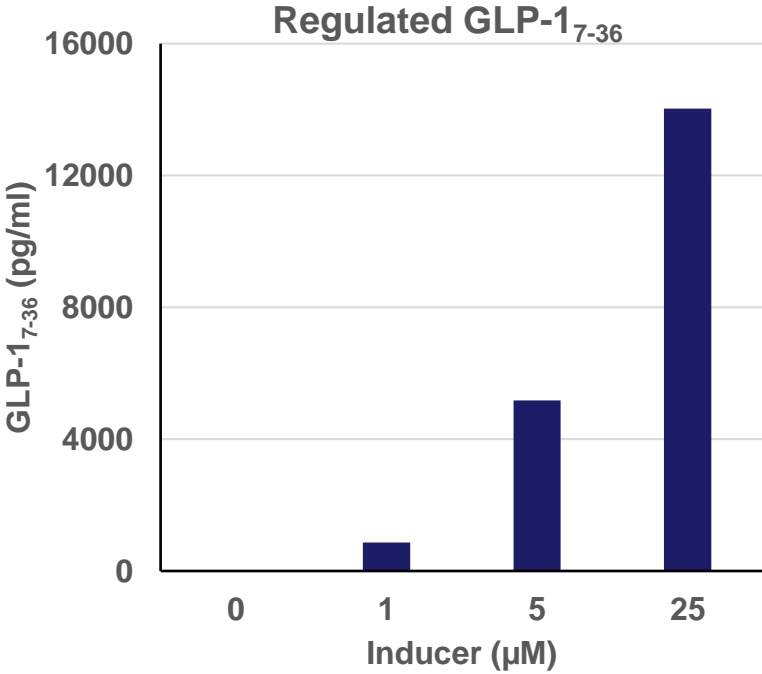
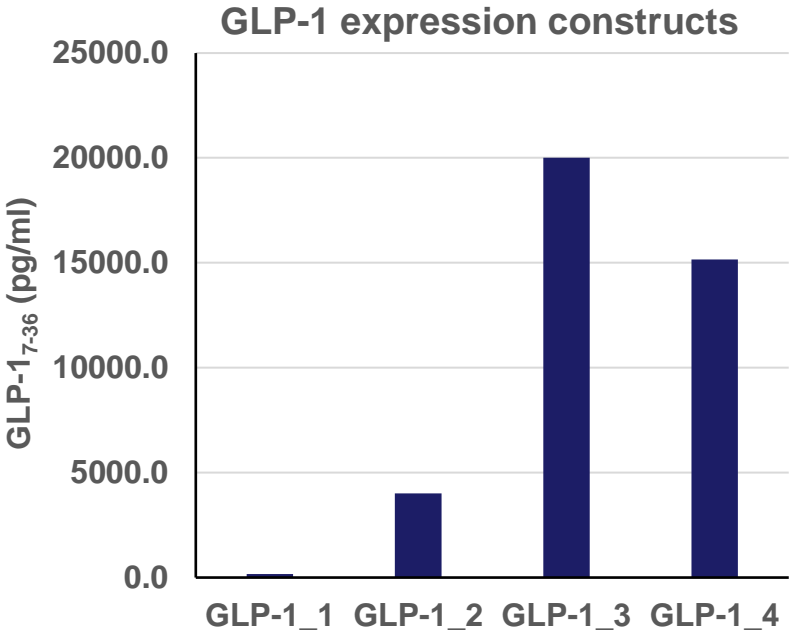
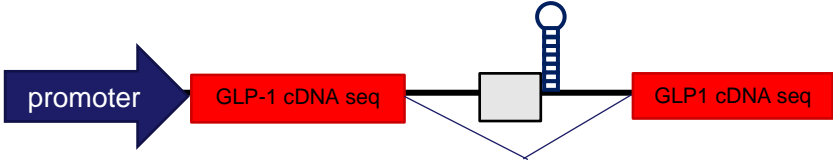



# Gene Regulation Cassette Controls the Expression of Combinations of Gut Peptides, GLP-1 plus GIP and PYY

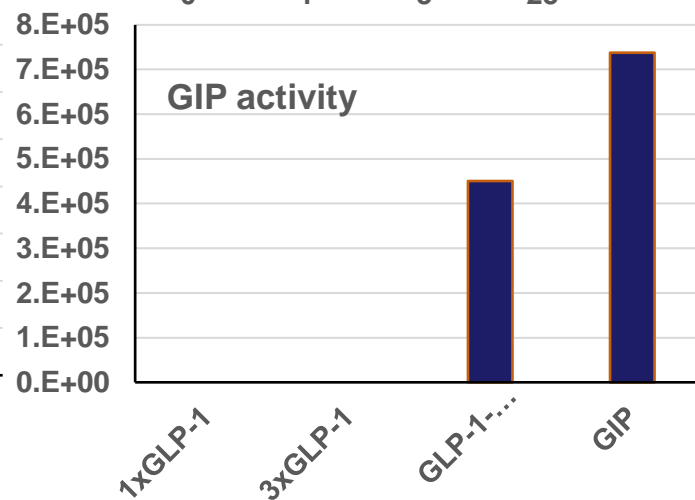
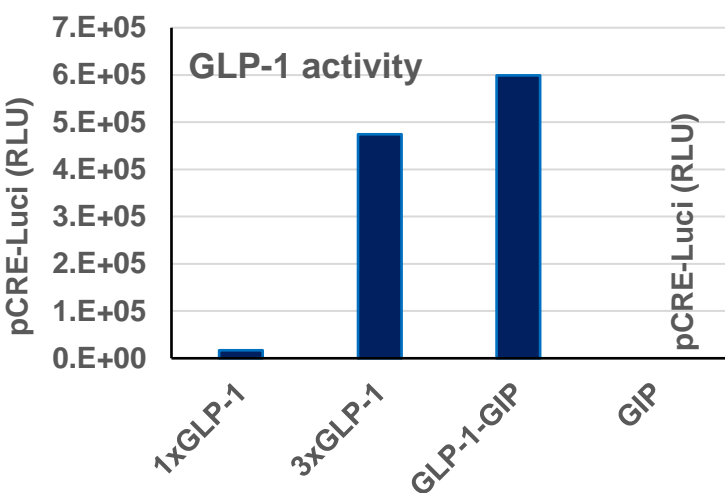
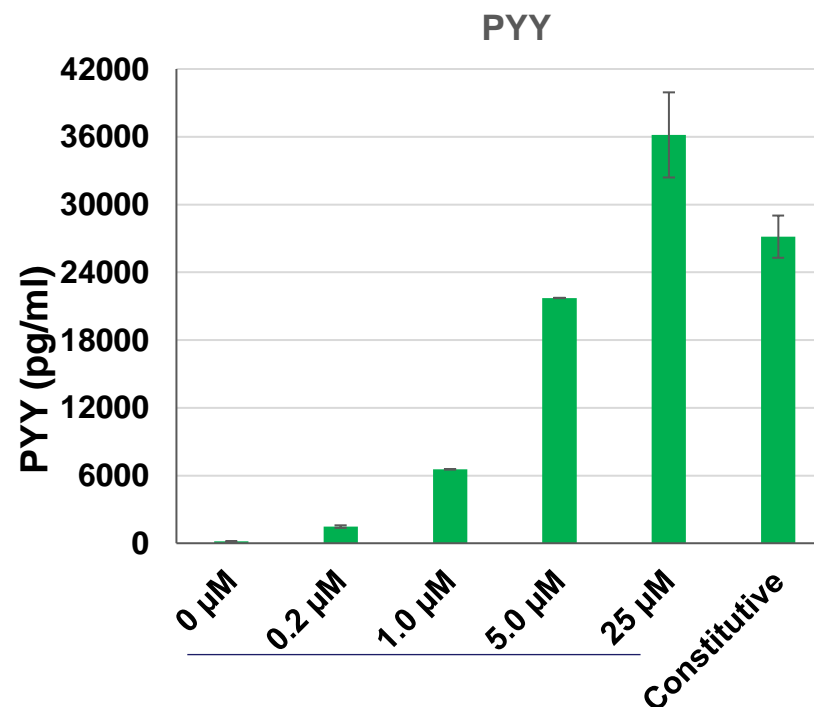
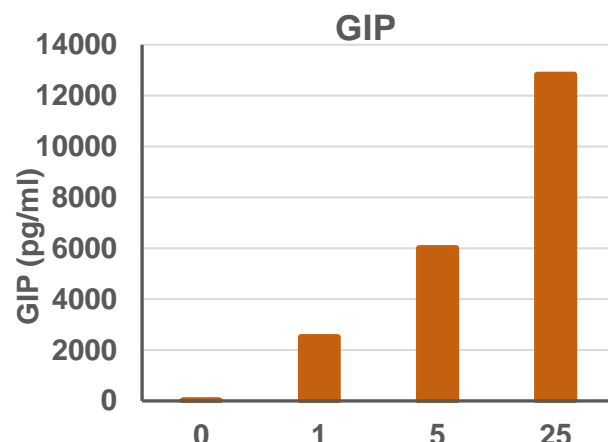
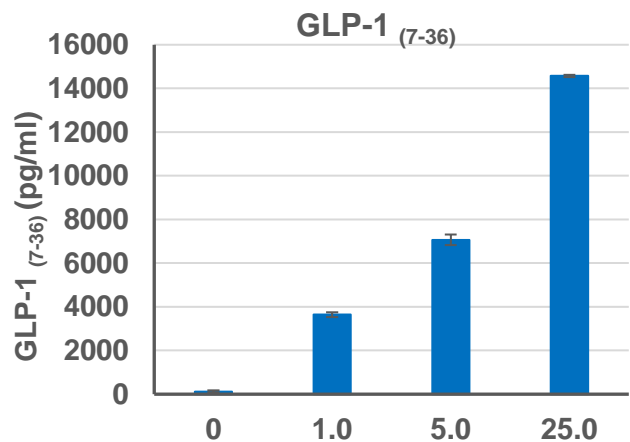
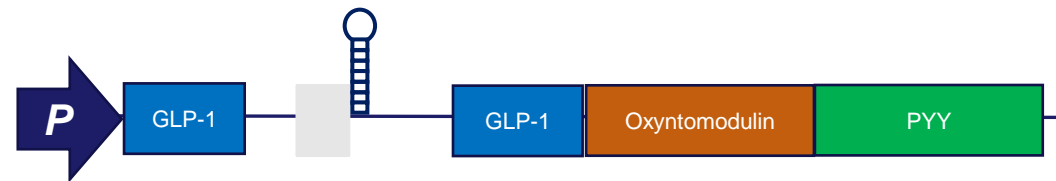
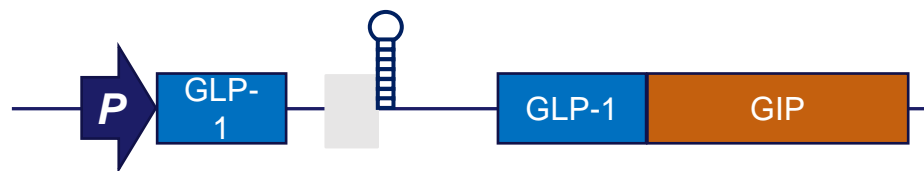

# Combination of Gut Peptides, GLP-1 and GIP, Regulated by Orally Delivered Small Molecule Improves Glucose Tolerance in Rodents

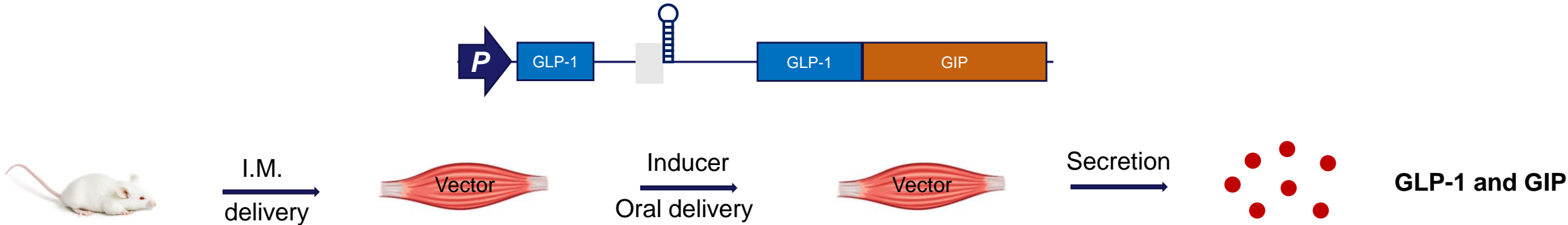

Glucose tolerance

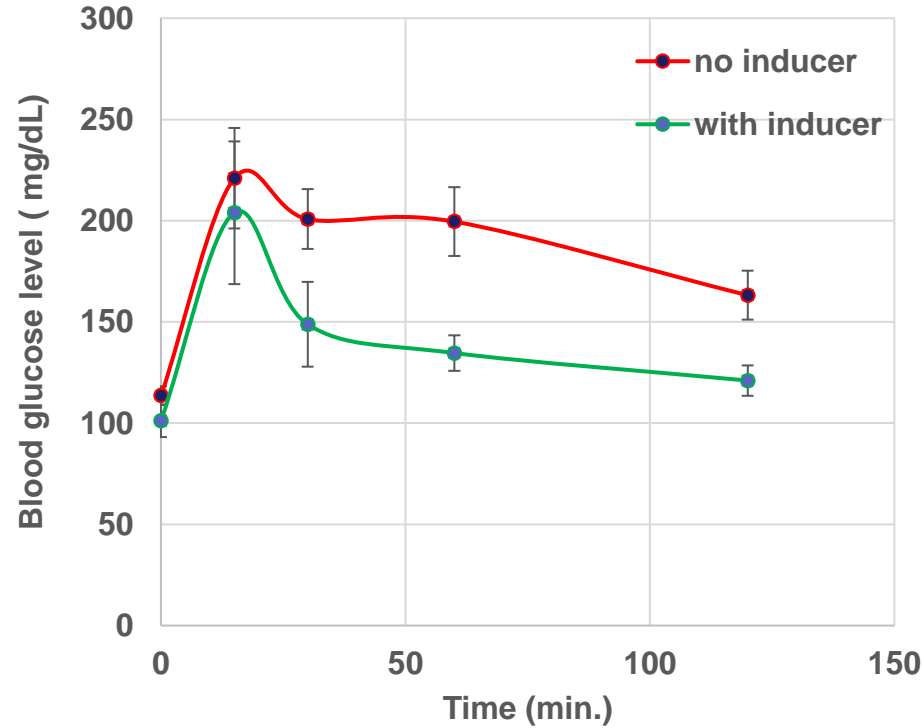

# Target Tissues for Production of Regulated Gene Therapy: Eye and Salivary Gland

## The Eye

### Gene Regulation with small molecule

- Regulate gene therapies using small molecule formulated as a **topical eye drop**
- Ophthalmological formulation of current strong specific inducer small molecules into eye drops during 2022

### Large Ocular Indications:

- **Wet AMD** : regulated VEGFR2
- **Dry AMD** : regulated anti-complement
- **Uveitis** : regulated cytokine inhibitor
- **Glaucoma**: regulated inhibitors of water flow (AQP1) and fibrosis

### Large Ocular Vectorology Toolkit

- Retinal organoid technology – vectorology and phenotype rescue
- Promoter engineering - enhanced potency and activity – Meira library of strong cell specific as well as ubiquitous promoters
- Regulatory elements, enhancers, introns, polyA, and codon optimization
- Capsid engineering: Ongoing NHP directed evolution screen for capsids for all parts of the eye – including cells towards the front of the eye that can secrete therapeutic proteins into the vitreous
- Delivery: Intravitreal and Suprachoroidal Delivery – Multiple proprietary technologies under development

### Reduced Inflammation

- Delivery technology, capsid and site of transduction
- Construct design to block innate immune response
- Well tested effective prophylactic regimens

## Salivary Gland

### Salivary Gland as a Secretory Organ for Genetic Medicines

- Parotid is one of the largest secretory organs in the body
- Specific signal peptides drive secretion **into the serum** rather than saliva
- Epo, PTH and hGH have all been shown to be secreted from salivary glands when the transgene is delivered into the parotid in rodent and mini-pigs
- Expression levels are therapeutic and durable

### We have Vectorology and Clinical Experience of Salivary Gland Gene Therapy

- Easy administration – retro-ductal instillation via Stensen's Duct
- Small dose locally delivered
- AAV2 local delivery gives minimal serum exposure
- Durable expression expected as salivary gland cells – both acinar but also duct cells are differentiated and not rapidly turning over

### Targets for Salivary Gland Regulation:

- **Gut Peptide Combinations: Metabolic Disease and Obesity** – alternative to Bariatric Surgery
- **Genetic Endocrine Deficiency Disorders**
- **hPTH**: Hypoparathyroidism, congenital, autoimmune, acquired
  - Unmet need because of short half life of natural PTH 1-34; hypercalciuria, impaired renal function and renal failure
  - Osteoporosis
- **hGH**: Growth factor deficiency
- **hEpo**: kidney disease
- **Insulin**: Diabetes - basal and post prandial insulin

### Current Small Molecules with Good Salivary Gland Exposure:

- Regulates gene therapies in rodent parotid
- Small Molecule IND 2022
- IND enabling studies of Vector Constructs together with small molecules 2022



## Vectorized Biologics

We can not only vectorize and optimize viral vectors for expressing Antibodies and other therapeutic proteins – but we can precisely control their expression: rare disease gene replacement consistency of dosing or systemic Vectorized Antibodies  
Improved **Safety** and Consistency of dosing between patients



## Passive and Active Vaccines with built-in capacity for Oral Small Molecule Boosters

**Active Vaccine:** regulated vaccine mRNA can be boosted multiple times any time after first IM delivery as needed with an oral pill

**Passive Vaccine:** neutralizing antibodies activated systemically and durably as needed with an **oral pill** e.g., COVID-19, universal flu



## CNS expression of biologics – across the BBB

Potential to address one of the biggest challenges in medicine: getting large molecules across the blood-brain-barrier  
Gene Therapy delivered 1x within the BBB and activated using a small molecule that crosses the BBB



## Short-lived Therapeutic Hormones and Peptides

Precise activation of naturally short-lived peptides and hormones using an oral pill; and allows for combinations of multiple natural peptides regulated together.



## Ocular expression of therapeutic proteins

Tight control of expression of therapeutic proteins in the eye with eye drop formulation of small-molecule inducer; improved safety and new targets



## Gene Editing

Tight regulation of nucleases targeting DNA or RNA e.g., Cas9 and CasRx



## Cell Therapy

Controlled expression of CAR, 'Kill switches'; both 'on' and 'off' switches



## Pricing of Gene Therapies

Pay for the pill which delivers the active therapeutic protein, not just the 1x delivery of the gene therapy



# Unique Technologies Transform the Fields of Genetic Medicine and Biologic Drugs

## For the first time, a Synthetic Gene Regulation System precisely and specifically controls the activity of genetic medicines using orally dosed pills

- ❖ Gene Regulation Cassette driven by novel mammalian Riboswitches
- ❖ Gene regulation at unprecedented high dynamic range
- ❖ Precise, tight control of genetic medicines by novel small molecules
- ❖ Any gene, any vector; cell therapy, gene editing can be controlled with this system
- ❖ Currently >15 targets have been built that are vectorized at Meira, optimized and tightly regulated,
- ❖ With vectorology and gene regulation toolkit we can rapidly build new regulated genetic therapies
- ❖ Libraries of small molecules specifically designed to match synthetic aptamers, with different drug properties
- ❖ Both regulated viral vectors and small molecules are currently in IND enabling studies
- ❖ We have particular expertise in expression of gene therapies in the eye, salivary gland and muscle, all good sites for local delivery of regulated gene therapies
- ❖ This platform technology provides boundless opportunity and transforms genetic medicine
- ❖ New paradigm for delivery and pricing of gene therapies as well as biologic drugs

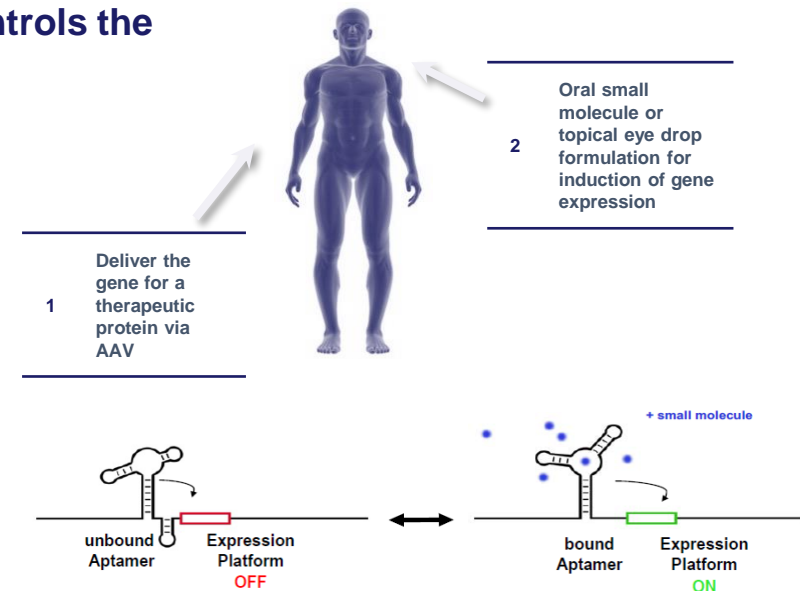

Therapeutic Antibodies:	Therapeutic Hormones/Cytokines/Peptides:	Therapeutic Nucleases (Targeting RNAs):
<ul style="list-style-type: none"> <li>• Anti-PCSK9</li> <li>• Anti-VEGFR2 (ophthalmology)</li> <li>• Anti-Amyloid</li> <li>• Anti-IL-17</li> <li>• Anti-PD1</li> <li>• Anti-HER2</li> </ul>	<ul style="list-style-type: none"> <li>• <u>Epo</u></li> <li>• <u>hGH</u></li> <li>• PTH</li> <li>• Insulin</li> <li>• GLP-1R agonists</li> <li>• Gut peptide combinations: GLP1- GIP; GLP1 GIP PYY Glucagon etc.</li> </ul>	<ul style="list-style-type: none"> <li>• Cas9</li> <li>• <u>CasRx</u></li> </ul>



# Q&A Session





MEIRAGTx